

The background is a solid red color with a repeating pattern of white line-art icons representing various electrical components. These include light bulbs, electrical boxes, switches, outlets, cables, and connectors, scattered across the entire page.

eurolux
Electrical

2018

**ELECTRICAL
CATALOGUE**

CAPE TOWN - Head Office



9 Racecourse Road
Milnerton
7441
Tel: +27 (0)21 528 8400
Fax: +27 (0)21 528 8500
info@eurolux.co.za
www.eurolux.co.za



JOHANNESBURG



10 Milkyway Avenue
Linbro Business Park
Sandton
2065
Tel: +27 (0)11 608 2970
Fax: +27 (0)11 608 2975
jhb@eurolux.co.za
www.eurolux.co.za

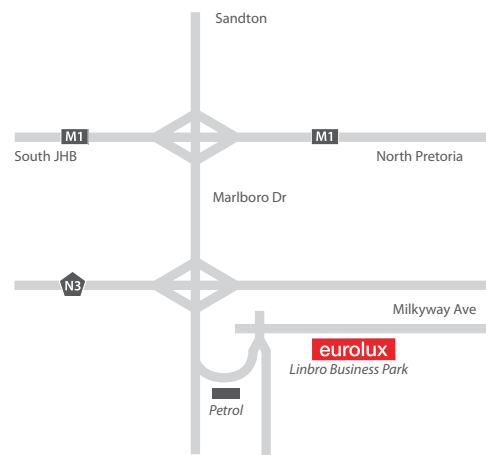









































DESIGN: Eurolux
REPRODUCTION: Eurolux

1. The 2018 edition of Eurolux's electrical catalogue ("the Catalogue") replaces all previous editions.
2. The Eurolux products listed in the Catalogue ("the Products") are supplied to selected wholesalers and retailers only ("the Authorised Merchants"). The Catalogue is made available for information and reference purposes only. It is supplied to, and may be used by, Authorised Merchants only. It is not intended for use or distribution to other persons. Authorised Merchants are bound by Eurolux's standard terms and conditions of trade.
3. Nothing in the Catalogue or any part thereof may be construed as an offer to supply or sell any Product to any person, or as an inducement or offer to any person to enter into a contract with Eurolux in respect of the supply of any Product.
4. Subject to all applicable law, Eurolux:
 - 4.1 Accepts no responsibility for any loss or damage, of whatsoever nature, arising in any way out of the use of or reliance on information contained in this Catalogue;

- 4.2 Makes no representations as to the availability of any Product and reserves the right to modify or discontinue a Product without notice, and to change Product specifications and descriptions without notice;
- 4.3 Accepts no responsibility for misprints, errors, omissions or inaccuracies in this Catalogue;
- 4.4 Makes no warranties, expressed or implied, in this Catalogue, save as recorded in clause 5 below.
5. All Products carry a minimum one (1) year warranty against manufacturing defects.
6. As the features and colours of a Product may be reproduced inexactly in the printing and photography process, this Catalogue is merely a guide.
7. All rights reserved. No part of this publication (including the text and images) may be modified, copied, reproduced, stored in a retrieval system, transmitted or distributed in any form or by any means (whether electronic, mechanical, photocopying or otherwise), without the prior, express, written permission of Eurolux.

Electrical Catalogue 2018

Cable Ties	1	
Cable Clips	2	
Insulation Tape	3	
Gel Joints & Cable Joint Kits	4	
Cables	5-6	
Pre-Insulated Terminals	7	
Connector Strips	8	
Trunking	9	
Switches, Nipples & Nuts	10	
Lamp Holders	11-13	
Galleries, Bowls, Kits & Bulkheads	14-15	
Adaptors	16	
Multi-Plugs	17-18	
Extensions	19	
Janus Couplers, Plug Tops	20	
Ready Boards	21	
Steel & Plastic Din Rail Distribution Boards	22-24	
Electrical Enclosures	25-26	
Waterproof Isolators	27	
Plug-in Timer & Time Switch	28	
Conduit, Conduit Tools & Conduit Accessories	29-33	
Wall, Weatherproof & Extension Boxes	34	
Magnetic Ballasts	35	
Electronic Ballast Fluorescent Multiple Lamps	36-37	
Electronic Ballast Fluorescent Multiple PL Lamps	38	
Electronic Ballast Fluorescent	39-40	
Magnetic HID Ballasts	41	
Ignitors & Capacitors	42	
Electronic Control Gear HID	43	
LED Modules	44-46	
LED Constant Current Drivers	47-48	
Bluetooth	49-51	
Aluminium Profile	52	
Transformers & Drivers	53	
Fluorescent Starters, Backups & Dimmer Modules	54	
Work Lights	55-57	
Sensors	58	
Extractor Fans	59	
Tools	60	
Multimeters	61-62	
Index	63-64	

Cable Ties

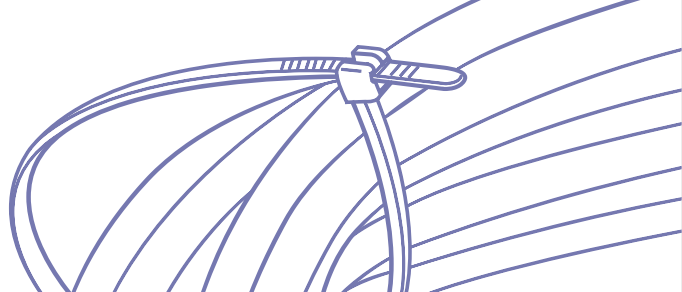

Cable Ties



These high tensile strength cable ties all feature internal serrations, enabling a positive hold onto numerous applications, such as cables, hoses and pipe bundles. The bent tail ensures a simple and quick installation.



Store in sealable polyethylene plastic bag



Do not store near direct heat



Ideal storage conditions are: 50% humidity and 23° Celcius

Code	Colour	Material	Length	Width	Min Tensile Strength	Special Features	Pack Size	Box Qty.	Barcode
ET1	Black	Polyamide 6.6	100mm	2.5mm	80N	UV Protected	100	500	6007328350330
ET2	Natural	Polyamide 6.6	100mm	2.5mm	80N	No UV Protection	100	500	6007328350347
ET3	Black	Polyamide 6.6	150mm	3.5mm	135N	UV Protected	100	500	6007328350354
ET4	Natural	Polyamide 6.6	150mm	3.6mm	135N	No UV Protection	100	500	6007328350361
ET5	Black	Polyamide 6.6	200mm	4.6mm	225N	UV Protected	100	500	6007328350378
ET6	Natural	Polyamide 6.6	200mm	4.8mm	225N	No UV Protection	100	500	6007328350385
ET7	Black	Polyamide 6.6	300mm	4.6mm	225N	UV Protected	100	500	6007328350392
ET8	Natural	Polyamide 6.6	300mm	4.8mm	225N	No UV Protection	100	500	6007328350408
ET9	Black	Polyamide 6.6	390mm	4.6mm	225N	UV Protected	100	500	6007328350415
ET10	Natural	Polyamide 6.6	400mm	4.8mm	225N	No UV Protection	100	500	6007328350422
ET11	Black	Polyamide 6.6	390mm	7.6mm	535N	UV Protected	50	500	6007328350439

Cable Clips

Cable Clips

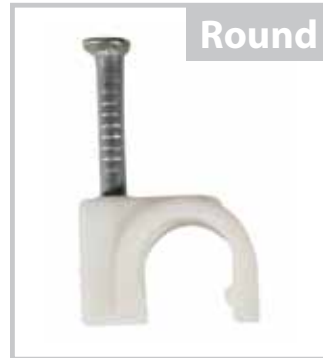

Code	Shape	Material	Diameter	Nail	Pack Size	Box Qty.	Barcode
EA71	Flat	PVC	5.0mm	15mm x 1.5mm	100	400	6007328351603
EA72	Flat	PVC	8.5mm	29mm x 2mm	100	300	6007328351610
EA73	Flat	PVC	10.5mm	29mm x 2mm	100	200	6007328351627
EA74	Round	PVC	6.0mm	20mm x 1.5mm	100	400	6007328351634
EA75	Round	PVC	7.0mm	20mm x 1.5mm	100	400	6007328351641
EA76	Round	PVC	8.0mm	20mm x 1.5mm	100	300	6007328351658
EA77	Round	PVC	9.0mm	29mm x 2mm	100	200	6007328351665
EA78	Round	PVC	10.0mm	29mm x 2mm	100	200	6007328351672
EA79	Round	PVC	12.0mm	29mm x 2mm	100	200	6007328351689
EA170	Round	PVC	20.0mm	38mm x 3mm	50	200	6007328358718

Insulation Tape

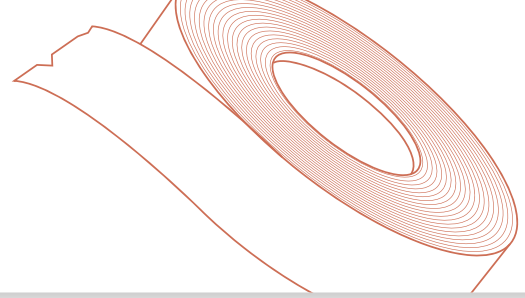

Insulation Tape

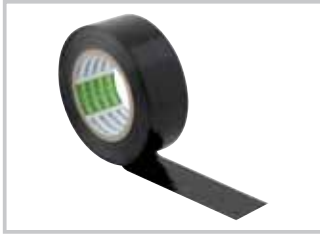

ET101BK

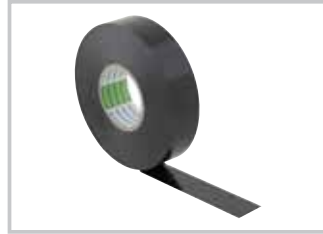

ET100BK

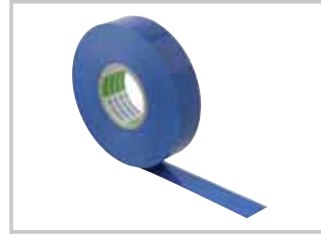

ET100BLK

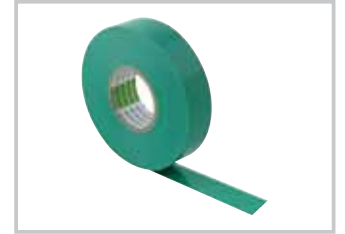

ET100GK



ET100RK



ET100WK



ET100YK

Nitto

Adhesive Strength - 3.51N/19mm
 Tensile Strength - 61.6N/19mm
 Elongation - 251%
 Dielectric Breakdown Voltage - 56.9kV/mm

Nitto Code	Code	Colour	Material	Length	Width	Thickness	Pack Size	Box Qty.	Barcode
No. 201	ET101BK	Black	Lead-Free Vinyl	10m	19mm	0.2mm	10	360	6007328371441
No. 21	ET100BK	Black	Lead-Free Vinyl	20m	19mm	0.2mm	10	200	6007328371458
No. 21	ET100BLK	Blue	Lead-Free Vinyl	20m	19mm	0.2mm	10	200	6007328371465
No. 21	ET100GK	Green	Lead-Free Vinyl	20m	19mm	0.2mm	10	200	6007328371472
No. 21	ET100RK	Red	Lead-Free Vinyl	20m	19mm	0.2mm	10	200	6007328371489
No. 21	ET100WK	White	Lead-Free Vinyl	20m	19mm	0.2mm	10	200	6007328371496
No. 21	ET100YK	Yellow	Lead-Free Vinyl	20m	19mm	0.2mm	10	200	6007328371502

Gel Joints & Cable Joint Kits

Cable Joint Kits



EX61FW



EX61RB

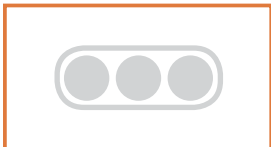

FB/FW - Flat Cable



RB/RW - Round Cable

Code	Cable Size	Min Cable	Max Cable	Max strip Length	Max Length	Pack Size	Max Width	Resin Bag/ Materials	Tape	Connector Spacer	Barcode
EX61FB	1.00 - 2.50	8.5mm	12mm	33mm	67mm	80	20mm	yes	no	yes	6007328370147
EX61FW	1.00 - 2.50	8.5mm	12mm	33mm	67mm	80	20mm	yes	no	yes	6007328370154
EX61RB	1.00 - 2.50	8.5mm	12mm	33mm	67mm	80	20mm	yes	no	yes	6007328370161
EX61RW	1.00 - 2.50	8.5mm	12mm	33mm	67mm	80	20mm	yes	no	yes	6007328370178

Cables

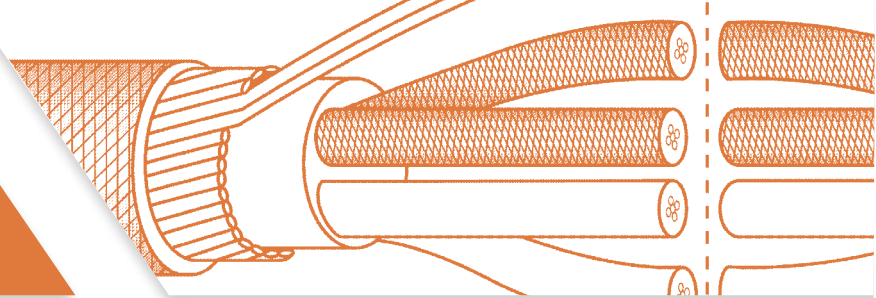

General Purpose Wire



Code	Cable Diameter	Colour	Length	Barcode
EW1	1.5mm	Red	100m	6007328362500
EW2	1.5mm	Black	100m	6007328362517
EW3	1.5mm	Green/Yellow	100m	6007328362524
EW4	1.5mm	Blue	100m	6007328362531
EW5	1.5mm	White	100m	6007328362548
EW6	2.5mm	Red	100m	6007328362555
EW7	2.5mm	Black	100m	6007328362562
EW8	2.5mm	Green/Yellow	100m	6007328362579
EW9	2.5mm	Blue	100m	6007328362586
EW10	2.5mm	White	100m	6007328362593
EWGP155B	1.5mm	Black	5m	6007328380245
EWGP155GY	1.5mm	Green/Yellow	5m	6007328380252
EWGP155R	1.5mm	Red	5m	6007328380269
EWGP2510B	2.5mm	Black	10m	6007328380399
EWGP2510GY	2.5mm	Green/Yellow	10m	6007328380405
EWGP2510R	2.5mm	Red	10m	6007328380412
EWGP2520B	2.5mm	Black	20m	6007328380429
EWGP2520GY	2.5mm	Green/Yellow	20m	6007328380436
EWGP2520R	2.5mm	Red	20m	6007328380443

Flat Twin & Earth Wire



Code	Cable Diameter	Colour	Length	Barcode
EW15	1.0mm	White	100m	6007328373537
EW13	1.5mm	White	100m	6007328362869
EW14	2.5mm	White	100m	6007328362876
EW16	4.0mm	White	100m	6007328373544
EWF1510B	1.5mm	Black	10m	6007328367567
EWF1510W	1.5mm	White	10m	6007328367574
EWF1515W	1.5mm	White	15m	6007328380030
EWF1520W	1.5mm	White	20m	6007328367581
EWF1525W	1.5mm	White	25m	6007328367598
EWF1550W	1.5mm	White	50m	6007328367604
EWF155W	1.5mm	White	5m	6007328380023
EWF2510W	2.5mm	White	10m	6007328367611
EWF2515W	2.5mm	White	15m	6007328380054
EWF2520W	2.5mm	White	20m	6007328367628
EWF2525W	2.5mm	White	15m	6007328380054
EWF2550W	2.5mm	White	50m	6007328367642
EWF255W	2.5mm	White	5m	6007328380047

Surfix Round Cable

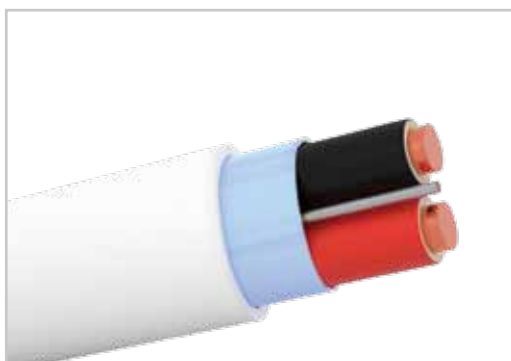

Code	Cable Diameter	Cores	Colour	Length	Barcode
EW11	1.5mm	2 + Earth	White	100m	6007328362609
EW12	2.5mm	2 + Earth	White	100m	6007328362616
EWS1510W	1.5mm	2 + Earth	White	10m	6007328367772
EWS1515W	2.5mm	2 + Earth	White	15m	6007328380221
EWS1520W	1.5mm	2 + Earth	White	20m	6007328380238

Cabtyre

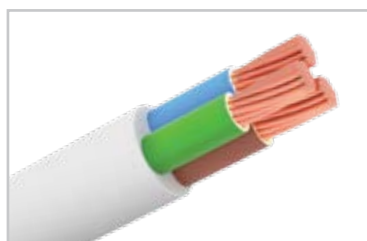

Code	Cable Diameter	Colour	Length	Barcode
EW17	1.0mm	White	100m	6007328381419
EW18	1.0mm	Black	100m	6007328381426
EW19	1.5mm	White	100m	6007328381433
EW20	1.5mm	Black	100m	6007328381440
EW21	2.5mm	White	100m	6007328381457
EW22	2.5mm	Black	100m	6007328381464
EWC135B	1.0mm	Black	5m	6007328367321
EWC135W	1.0mm	White	5m	6007328367338
EWC15310B	1.5mm	Black	10m	6007328367420
EWC15310W	1.5mm	White	10m	6007328367437
EWC15315W	1.5mm	White	15m	6007328380160
EWC15320B	1.5mm	White	20m	6007328380177
EWC15320W	1.5mm	White	20m	6007328380184
EWC15325B	1.5mm	Black	25m	6007328367444
EWC15325W	1.5mm	White	25m	6007328367451
EWC15350B	1.5mm	White	50m	6007328367468
EWC15350W	1.5mm	White	50m	6007328367475
EWC1535B	1.5mm	Black	5m	6007328367406
EWC1535W	1.5mm	White	5m	6007328367413
EWC25310B	2.5mm	Black	10m	6007328367505
EWC25310W	2.5mm	White	10m	6007328367512
EWC25315W	2.5mm	White	15m	6007328380191
EWC25320W	2.5mm	White	20m	6007328380207
EWC25325B	2.5mm	Black	25m	6007328367529
EWC25325W	2.5mm	White	25m	6007328367536
EWC2535B	2.5mm	Black	5m	6007328367482
EWC2535W	2.5mm	White	5m	6007328367499
EWC25350B	2.5mm	White	50m	6007328367543
EWC25350W	2.5mm	White	50m	6007328367550

Ripcord



Code	Cable Diameter	Colour	Length	Barcode
EW23	0.5mm	White	100m	6007328381471
EW24	0.5mm	Black	100m	6007328381488
EW25	0.5mm	Clear	100m	6007328381495
EWR055BL	0.5mm	Black	5m	6007328367659
EWR055BR	0.5mm	Brown	5m	6007328367680
EWR055CL	0.5mm	Clear	5m	6007328367758
EWR055W	0.5mm	White	5m	6007328367765
EWR0510BL	0.5mm	Black	10m	6007328367666
EWR0510BR	0.5mm	Brown	10m	6007328367697
EWR0510CL	0.5mm	Clear	10m	6007328367710
EWR0510W	0.5mm	White	10m	6007328367727
EWR0520BL	0.5mm	Black	20m	6007328367673
EWR0520BR	0.5mm	Brown	20m	6007328367703
EWR0520CL	0.5mm	Clear	20m	6007328367734
EWR0520W	0.5mm	White	20m	6007328367741
EWR0550BL	0.5mm	Black	50m	6007328367857
EWR0550CL	0.5mm	Clear	50m	6007328367840
EWR0550W	0.5mm	White	50m	6007328367833

Pre-Insulated Terminals







Multipacks



Barcode:
6007328363040

EA225 - 175 Pack





40

Cable Size (mm ²)						
0.5 - 1.5		1.5 - 2.5		4 - 6		
Screw Diameter (mm)						
Ø	Qty.	Ø	Qty.	Ø	Qty.	
	3.2	15	3.2	15	5.3	5
	4.3	10	4.3	10	6.5	5
	5.3	10	5.3	10	-	-
	3.2	10	4.3	10	-	-
	4.3	10	-	-	-	-
Tab Dimensions (mm)						
Ø	Qty.	Ø	Qty.	Ø	Qty.	
	0.8 x 6.35	10	0.8 x 6.35	10	-	-
	0.8 x 6.35	10	0.8 x 6.35	10	-	-
Wire Diameter (mm)						
Ø	Qty.	Ø	Qty.	Ø	Qty.	
	1.7	10	2.3	5	3.4	10

Barcode:
6007328363057

EA226 - 300 Pack

40

Cable Size (mm ²)						
0.5 - 1.5		1.5 - 2.5		4 - 6		
Screw Diameter (mm)						
Ø	Qty.	Ø	Qty.	Ø	Qty.	
	3.2	25	3.2	15	5.3	5
	4.3	25	4.3	20	6.5	5
	5.3	25	5.3	10	-	-
	3.2	20	4.3	20	-	-
	4.3	20	-	-	-	-
Tab Dimensions (mm)						
Ø	Qty.	Ø	Qty.	Ø	Qty.	
	0.8 x 6.35	20	0.8 x 6.35	20	-	-
	0.8 x 6.35	20	0.8 x 6.35	20	-	-
Wire Diameter (mm)						
Ø	Qty.	Ø	Qty.	Ø	Qty.	
	1.7	10	2.3	10	3.4	10

Connector Strips

PVC Connector Strips



Code	Amps	Wire Size	No. of Terminals	Colour	Pack Size	Barcode
EAC64K	3	0.75mm	12	Black	10	6007328370215
EA67	5	0.75mm	12	Black	10	6007328351320
EA199	10	1.0mm	12	Black	10	6007328362432
EA65	15	1.5mm	12	Black	10	6007328351306
EA66	30	2.5mm	12	Black	10	6007328351313

Terminal Connector (Fused)



Code	Amps	Wire Size	No. of Terminals	Colour	Pack Size	Barcode
EFH50K	6	0.75mm	3	Natural	100	6007328372943

Complete With Replaceable Fuse

Porcelain Connector Blocks



1 way			
Code	Current	Box Qty.	Barcode
EAC61	5Amp	1000	6007328370222
EAC151K	15Amp	1000	6007328370253

2 way			
Code	Current	Box Qty.	Barcode
EAC62K	5Amp	1000	6007328370239
EAC152K	15Amp	1000	6007328370260

3 way			
Code	Current	Box Qty.	Barcode
EAC63K	5Amp	1000	6007328370246
EAC153K	15Amp	1000	6007328370277

Scruts



Code	Type	Colour	Material	Length	Diameter	Pack Size	Barcode
EA84	Midget	White	Ceramic	17mm	11mm	1000	6007328352037
EA85	Normal	White	Ceramic	23mm	14mm	1000	6007328352044

Trunking



Trunking

Trunking is an enclosure provided for the protection of cables which are usually square or rectangular in cross-section, having one removable side. Trunking may be thought of as simply a larger and more accessible conduit system.

PVC Trunking

The main areas in which PVC trunking is used are domestic and office premises.

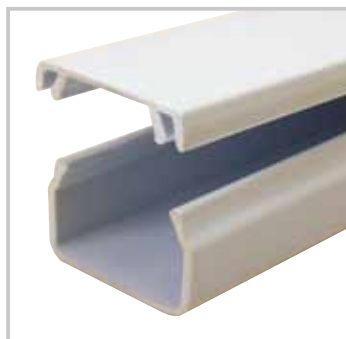

Code	Height	Width	Length	Pack Size	Barcode
EA120	16mm	16mm	2.0m	40	6007328354024
EA228	16mm	16mm	2.9m	40	6007328363699
EA121	16mm	25mm	2.9m	25	6007328354031
EA122K	16mm	40mm	2.9m	20	6007328354048
EA123K	25mm	40mm	2.9m	10	6007328354055
EA124K	40mm	40mm	2.9m	10	6007328354062
EA229K	100mm	40mm	2.9m	2	6007328363705

NB: Only Sold in Pack Sizes

Switches, Nipples & Nuts

Switches



EA87 100
Black Plastic Inline Rocker Switch
2A 250V
(L)60mm x (W)20mm x (D)17mm
6007328352068



EA86 100
White Plastic Inline Rocker Switch
2A 250V
(L)60mm x (W)20mm x (D)17mm
6007328352051



CO72B 300
Black Plastic Foot Switch
6A 250V
(Ø)70mm x (D)29mm
6007328336891



CO72W 200
White Plastic Foot Switch
6A 250V
(Ø)70mm x (D)29mm
6007328029007



EA174 100
White Ceiling Pull Switch
10A
(Ø)76mm x (D)43mm
Cord Length: 1620mm
6007328359173



ESW2 100
Fan 3 Speed Switch
250V
(H)35mm x (W)25mm
6007328371526



ESW1 100
Canopy Pull Switch
250V
(H)35mm x (W)25mm
6007328371519

Nipples & Nut



Code	Material	Diameter	Length	Box Qty.	Barcode
CO46	Steel	10mm	15mm	1000	6007328029014
CO53	Steel	10mm	20mm	1000	6007328029021
CO54	Steel	10mm	25mm	1000	6007328029038
CO55	Steel	10mm	30mm	1000	6007328029045

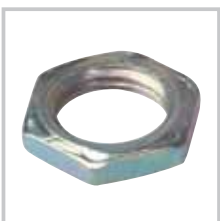

CO45 2000
Steel Lock Nut
For CO46, CO53-55
(Ø)10mm x (D)3mm
6007328029168

Lamp Holders

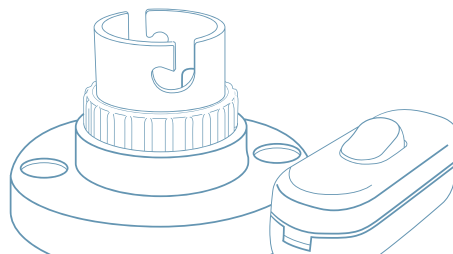

Nylon Lamp Holders



EA179B  720
B22 Black Nylon
10mm Back Entry
2A 250V~100W
(H)52mm x (Ø)34mm
6007328359234



EA177B  480
B22 Black Nylon
Batten Lamp Holder
2A 250V~100W
(H)40mm x (Ø)64mm
6007328359210



EA179W  720
B22 White Nylon
10mm Back Entry
2A 250V~100W
(H)52mm x (Ø)34mm
6007328359227



EA177W  480
B22 White Nylon
Batten Lamp Holder
2A 250V~100W
(H)40mm x (Ø)64mm
6007328359203

Brass Lamp Holders



EA190  12
B22 Brass
10mm Cord Grip
2A 250V
(H)52mm x (Ø)32mm
6007328361107



CO44BR  12
B22 Brass
10mm Back Entry
2A 250V
(H)42mm x (Ø)32mm
6007328030089



EA182  12
B22 Brass
10mm Back Entry
Earth Screw
2A 250V
(H)42mm x (Ø)32mm
6007328359258



EA182P  12
B22 Brass Pushbar
Switch Lamp Holder
2A 250V
(H)42mm x (Ø)32mm
6007328370185



EA183  12
B22 Brass
20mm Back Entry
2A 250V
(H)42mm x (Ø)32mm
6007328359265



EA181  12
B22 Brass
Batten Lamp Holder
2A 250V
(H)35mm x (Ø)55mm
6007328359241



CO22BR  12
B22 Brass
Batten Lamp Holder
2A 250V
(H)35mm x (Ø)62mm
6007328030072



EA182F  100
Lamp Holder Brass
Flange 10mm
(H)42mm x (Ø)32mm
6007328370192

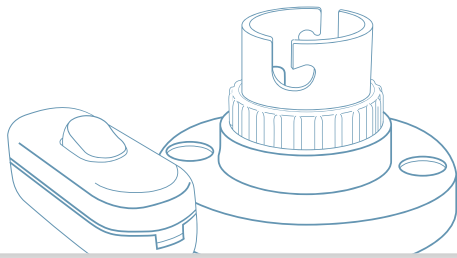

Lamp Holders



CO48  250
GU10 Ceramic
2A 250V
(H)18mm x (Ø)27mm
6007328334224



CO113  50
GU10 Ceramic
+ bracket + earth
2A 250V
(H)80mm x (Ø)30mm
6007328333166



CO47  20
GU5.3 Ceramic
4A 250V
(H)10mm x (Ø)17mm
6007328334217



CO185  500
GU10 → B22 Adapter
White Ceramic
2A 250V
(H)50mm x (Ø)35mm
6007328365884



CO183  500
GU10 → E27 Adapter
White Ceramic
2A 250V
(H)52mm x (Ø)35mm
6007328365860



CO184  500
GU10 → E14 Adapter
White Ceramic
2A 250V
(H)52mm x (Ø)35mm
6007328365877



EA184  400
B22 Porcelain
2A 250V
(H)40mm x (W)58mm
x (D)38mm
6007328359272



EA185  400
E27 Porcelain
4A 250V
(H)45mm x (W)33mm
x (D)33mm
6007328359289



EA186  600
B22 Black Bakelite
'Illumination'
2A 250V
(H)44mm x (W)53mm
x (D)36mm
6007328359296



CO30  40
E27
Natural Ceramic
4A 250V
(H)46mm x (Ø)42mm
6007328002789



CO33  80
E40
White Porcelain
16A 500V
(H)78mm x (Ø)59mm
6007328315087



CO190  100
E14 Full Thread &
10mm Cap & Ring
2A 250V
(H)43mm x (Ø)41mm
6007328367031



CO191  100
E14 Half Thread &
10mm Cap & Ring
2A 250V
(H)43mm x (Ø)41mm
6007328367048



CO192  100
E27 Full Thread &
10mm Cap & Ring
2A 250V
(H)41mm x (Ø)43mm
6007328367055



CO193  100
E27 Half Thread &
10mm Cap & Ring
2A 250V
(H)41mm x (Ø)43mm
6007328367062

Lamp Holders

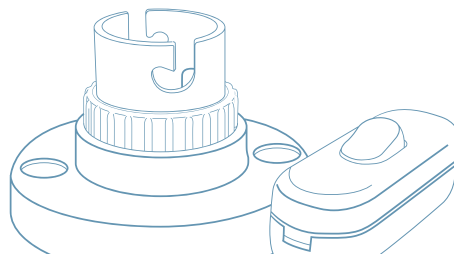

Lamp Holders



EFH10K  200
Fluorescent Holder T8
G13 Tombstone
(H)25mm x (W)35mm
x (D)23.5mm
6007328372868



EFH15K  500
Fluorescent Holder T8
G13 + Pin + Spring
(H)23mm x (W)37mm
x (D)13mm
6007328372875



EFH20K  500
Fluorescent Holder
T5 + Pins
(H)19mm x (W)25mm
x (D)9mm
6007328372882



EFH25K  500
Fluorescent Holder
T5 + Pins + Spring
(H)19mm x (W)25mm
x (D)9mm
6007328372899



EFH30K  100
Circline Holder
G10QA + Starter
Holder
(H)24mm x (W)42mm
x (D)19mm
6007328372905



EFH35K  200
Fluorescent Starter
Holder + Pins
(H)25mm x (W)33mm
x (D)12mm
6007328372912



EFH40K  100
PL Holder G23
Horizontal
(H)34mm x (W)31mm
x (D)35mm
6007328372929



EFH45K  100
PL Holder G23
Vertical
(H)34mm x (W)32mm
x (D)34mm
6007328372936

Galleries



CO153W  100
6" B22
White & Black PVC
250V~60W
(H)41mm x (Ø)106mm
6007328355007



CO154W  100
8" B22
White & Black PVC
250V~60W
(H)45mm x (Ø)120mm
6007328355014



CO155W  100
6" B22
White Fibre Glass
250V~100W
(H)47mm x (Ø)103mm
6007328355021



CO156W  100
8" B22
White Fibre Glass
250V~100W
(H)48mm x (Ø)118mm
6007328355038

Bowls



CO157  12
160mm Opal Bowl
Polycarbonate
(H)180mm x (Ø)160mm
6007328355045



CO158  40
200mm Opal Bowl
Polycarbonate
(H)180mm x (Ø)200mm
6007328355052



CO159  12
160mm Opal
Bowl Glass
(H)170mm x (Ø)160mm
6007328355069



CO160  12
200mm Opal
Bowl Glass
(H)200mm x (Ø)200mm
6007328355076



CO161  12
160mm Bowl
Amber Iced Glass
(H)175mm x (Ø)160mm
6007328355083



CO162  12
200mm Bowl
Amber Iced Glass
(H)200mm x (Ø)200mm
6007328355090

Galleries, Bowls & Kits

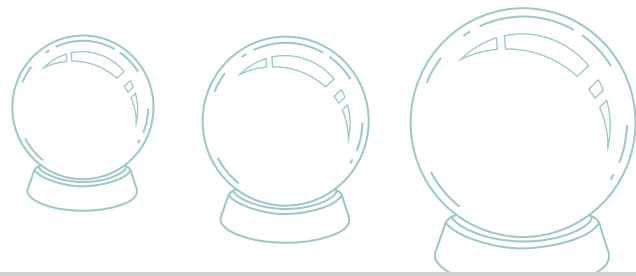

Bulkhead



B174  20
White / Diffused Plastic
Excl. 1 x B22 42W (max
60W) Halogen 230V
IP30
(H)110mm x (W)195mm
x (D)150mm
6007328355939



B181  20
Bulkhead
ABS with Acrylic lens
Excl. 1 x E27 15W 230V
IP44
(Ø)270mm x (D)90mm
BLACK: 6007328367864
WHITE: 6007328367871



B190  20
ABS Bulkhead with Black or
White Rim & Clear Acrylic Lens
Excl. 1 x E27 15W 230V
IP44
(Ø)270mm x (D)90mm
BLACK: 6007328380856
WHITE: 6007328380863

Budget Lights



EA233K  12
160mm Budget Light
White PVC Fitting
with Clear
Polycarbonate Bowl
IP40
4A 250V~60W
(H)190mm x (Ø)160mm
6007328371304



EA233  12
160mm Budget Light
White PVC Fitting
with Clear
Polycarbonate Bowl
Incl. B22 11W Cool White
CFL Lamp
IP40
4A 250V~60W
(H)190mm x (Ø)160mm
6007328371304



CO504  12
160mm Budget Light
White PVC Fitting with
Clear Polycarbonate Bowl
Incl. B22 6W Cool White
A60 LED Lamp
IP40
4A 250V~60W
(H)190mm x (Ø)160mm
6007328377405



EA231  12
160mm Budget Light
White PVC Fitting with
Opal Polycarbonate Bowl
IP40
4A 250V~60W
(H)195mm x (Ø)160mm
6007328370888



EA176  12
160mm Budget Light
White PVC Fitting with
Opal Polycarbonate Bowl
Incl. B22 11W Cool White
CFL Lamp
IP40
4A 250V~60W
(H)195mm x (Ø)160mm
6007328359197



EA278  12
160mm Budget Light
White PVC Fitting with
Opal Polycarbonate Bowl
Incl. B22 6W Cool White
A60 LED Lamp
IP40
4A 250V~60W
(H)190mm x (Ø)160mm
6007328385202

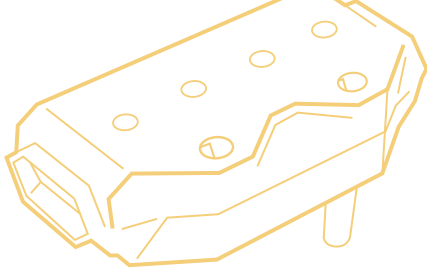

Adaptors



EP9  200
Top Entry
1 x 5A
6007328352082



EP10  160
Twin Euro
2 x 5A (top and bottom entry)
6007328352099



EP15  1
Bottom Entry
1 x 5A (bottom entry)
6007328352143



EP3  160
1 x 16A
2 x 5A (top entry)
6007328351375



EP13  280
Euro Continental
1 x 5A
1 x Schuko 10A
6007328352129



EP1  100
2 x 16A
6007328351351



EP12  1
4 Way
2 x 16A
2 x 5A (side entry)
6007328352112



EP16  100
1 x 10A
6007328352150



EP2  100
3 x 16A
6007328351368

Multi-Plugs

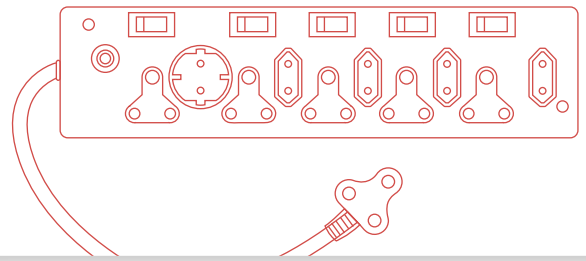

Surge Protected



EM5  30
Surge + Overload protection
⌚: 400mm
3 x 16A
3 x 5A
6007328351535





EM1  30
Surge + Overload protection
⌚: 420mm
5 x 16A
4 x 5A
1 x 5A Schuko
6007328351498

Switched

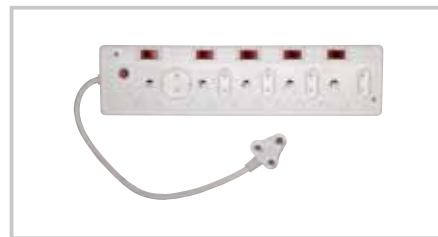

EM7  30
Overload protection
⌚: 410mm
3 x 16A
3 x 5A
3 x illuminated switches
6007328351559



EM6  30
Overload protection
⌚: 600mm
5 x 16A
4 x 5A
1 x 10A Schuko
5 x illuminated switches
6007328351542

Dedicated



EM19  30
Overload protection
⌚: 410mm
5 x 16A
6007328357902

Multi-Plugs

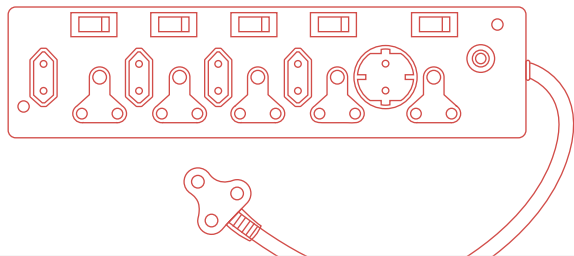

Non-Switched



EM2  30
Overload protection
⌚: 400mm
3 x 16A
6007328351504

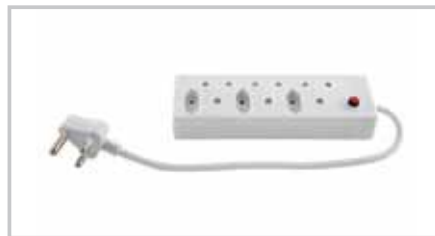

EM3  30
Overload protection
⌚: 400mm
3 x 16A
3 x 5A
6007328351511

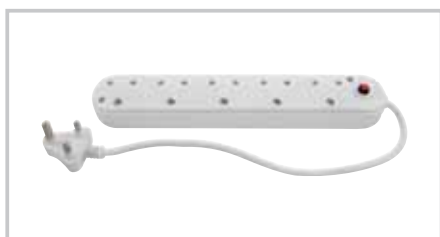

EM8  30
Overload protection
⌚: 400mm
5 x 16A
6007328351566



EM4  30
Overload protection
⌚: 400mm
5 x 16A
4 x 10A
1 x 5A Schuko
6007328351528

Extensions

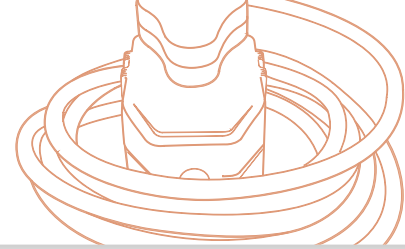

Cords



EA196  100
3m Cord set White
6A Plug top
6007328351597

Leads



No indicator light

Code	Cord Length	Cord Thickness	3 pin Sockets	Indicator Light	IP Rating	Amp	Box Qty.	Barcode
EE1	3m	1.0mm ²	2	No	20	10A	42	6007328351405
EE2	5m	1.0mm ²	2	No	20	10A	30	6007328351412
EE4	5m	1.5mm ²	2	No	20	16A	20	6007328351436
EE3	10m	1.0mm ²	2	No	20	10A	20	6007328351429
EE5	10m	1.5mm ²	2	No	20	16A	20	6007328351443
EE6	20m	1.5mm ²	2	No	20	16A	10	6007328351450

Reels

NOTE:

Please ensure that the reel is unrolled before use. Failure to do so will cause heat damage and render the warranty void.



Code	Cord Length	Cord Thickness	10A Shuko	6A Euro	3 Pin Socket	Indicator Light	Reset Button	Rocker Switch	IP Rating	Max Wattage / Current	Box Qty.	Barcode
EE7	10m	1.0mm ²	1		2	No	Yes	Yes	20	2800W / 10A	10	6007328351467
EE15	20m	1.0mm ²	-		2	No	No	Yes	20	10A	4	6007328360186
EE16	30m	1.5mm ²	-		2	No	No	Yes	20	10A	4	6007328360193
EE17	30m	2.5mm ²	-		2	No	No	Yes	20	16A	4	6007328360728
EE35	20m	1.0mm ²	1	1	1	Yes	Yes	Yes	20	10A	4	6007328351009
EE36	30m	1.5mm ²	1	1	1	Yes	Yes	Yes	20	16A	4	6007328351016

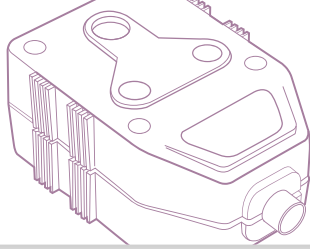

Janus Couplers & Plug Tops

16A Double Janus Couplers



EM9  100
Black
PVC
16A
6007328351573



EM10  200
White
PVC
16A
6007328351580



EP7  100
Black
Rubber
16A
6007328352020

16A Rewirable Plug Tops - Standard Range



EP6K  300
Black Rubber
Hollow Pin
16A
6007328352013



EP8K  300
White Nylon
Hollow Pin
16A
6007328352075



EP6SK  300
Black Rubber
Solid Pin
16A
6007328388241



EP8SK  300
White Nylon
Solid Pin
16A
6007328388258

Dedicated Plug Top



EP29K  300
Red Solid Pin
16A
6007328353324

Plug Protector



EP31  100
White
Plastic
4-pack incl. keys
6007328370918

Ready Boards



Ready Boards

Uses & Benefits

Low cost housing, small development, pre-wired with compliance certificate



EB23 1

Distribution Board:

12 Modules

Including: 1 x EEL1 Single phase earth leakage protection
2 x ECB34 20A Single pole circuit breaker

Sockets:

3 x 16A sockets with low load and high load options

Light:

Cream plastic bulkhead with clear diffuser (B174)
Excluding 1 x B22 60W 230V

6007328361381



EB24 1

Distribution Board:

12 Modules

Including: 1 x EEL1 Single phase earth leakage protection
2 x ECB34 20A Single pole circuit breaker

Sockets:

3 x 16A sockets with low load and high load options

6007328361398

Steel Din Rail Distribution Boards

Surface Mounted Distribution Boards



EB22  20
 4 Way Din Rail
 PVC housing & face
 IP66
 Indicator Light
 Lockable Lid
 (H)100mm x (W)206mm x (D)105mm
 6007328358701



EB17  20
 8 Way Din Rail
 Steel housing & PVC face
 Neutral Bar
 Earth Bar
 (H)221mm x (W)220mm
 x (D)103mm
 6007328354352



EB18  10
 12 Way Din Rail
 Steel housing & PVC face
 Neutral Bar
 Earth Bar
 (H)220mm x (W)280mm
 x (D)103mm
 6007328354369



EB19  10
 15 Way Din Rail
 Steel housing & PVC face
 Neutral Bar
 Earth Bar
 (H)220mm x (W)335mm
 x (D)105mm
 6007328354376



EB20  5
 24 Way Din Rail
 Steel housing & PVC face
 Neutral Bar
 Earth Bar
 (H)345mm x (W)300mm
 x (D)107mm
 6007328358688

Flush Mounted Distribution Boards



EB11  20
 8 Way Din Rail
 Steel housing & PVC face
 Neutral Bar
 Earth Bar
 (H)220mm x (W)210mm
 x (D)103mm
 Cut-out: (H)189mm x
 (W)180mm x (D)77mm
 6007328354291



EB12  10
 12 Way Din Rail
 Steel housing & PVC face
 Neutral Bar
 Earth Bar
 (H)225mm x (W)281mm
 x (D)103mm
 Cut-out: (H)190mm x
 (W)255mm x (D)75mm
 6007328354307



EB13  10
 15 Way Din Rail
 Steel housing & PVC face
 Neutral Bar
 Earth Bar
 (H)225mm x (W)335mm
 x (D)102mm
 Cut-out: (H)190mm x
 (W)310mm x (D)75mm
 6007328354314



EB21  5
 24 Way Din Rail
 Steel housing & PVC face
 Neutral Bar
 Earth Bar
 (H)344mm x (W)210mm
 x (D)103mm
 Cut-out: (H)310mm x
 (W)250mm x (D)76mm
 6007328358695

Plastic Din Rail Distribution Boards



Surface Mounted Plastic Distribution Boards



EB35  30
6 Way Din Rail
Plastic
Neutral Bar
Earth Bar
(H)200mm x (W)146mm
x (D)94mm
6007328369622



EB36  30
8 Way Din Rail
Plastic
Neutral Bar
Earth Bar
(H)200mm x (W)184mm
x (D)94mm
6007328369639



EB37  20
10 Way Din Rail
Plastic
Neutral Bar
Earth Bar
(H)200mm x (W)222mm
x (D)94mm
6007328369646



EB38  20
12 Way Din Rail
Plastic
Neutral Bar
Earth Bar
(H)200mm x (W)256mm
x (D)94mm
6007328369653



EB39  15
15 Way Din Rail
Plastic
Neutral Bar
Earth Bar
(H)200mm x (W)312mm
x (D)94mm
6007328369660



EB40  15
18 Way Din Rail
Plastic
Neutral Bar
Earth Bar
(H)220mm x (W)363mm
x (D)94mm
6007328369677



EB41  5
36 Way Din Rail
Plastic
Neutral Bar
Earth Bar
(H)458mm x (W)270mm
x (D)94mm
6007328369684

Plastic Din Rail Distribution Boards

Flush Mounted Plastic Distribution Boards



EB28  30
6 Way Din Rail
Plastic
Neutral Bar
Earth Bar
(H)222mm x (W)171mm
x (D)85mm
Cut-out: (H)200mm x
(W)151mm x (D)58mm
6007328370659



EB29  30
8 Way Din Rail
Plastic
Neutral Bar
Earth Bar
(H)222mm x (W)207mm
x (D)85mm
Cut-out: (H)200mm x
(W)188mm x (D)58mm
6007328370666



EB30  20
10 Way Din Rail
Plastic
Neutral Bar
Earth Bar
(H)222mm x (W)244mm
x (D)85mm
Cut-out: (H)200mm x
(W)222mm x (D)58mm
6007328370673



EB31  20
11 Way Din Rail
Plastic
Neutral Bar
Earth Bar
(H)222mm x (W)280mm
x (D)85mm
Cut-out: (H)200mm x
(W)260mm x (D)58mm
6007328370680



EB32  15
15 Way Din Rail
Plastic
Neutral Bar
Earth Bar
(H)222mm x (W)334mm
x (D)85mm
Cut-out: (H)200mm x
(W)302mm x (D)58mm
6007328370703



EB33  15
18 Way Din Rail
Plastic
Neutral Bar
Earth Bar
(H)251mm x (W)399mm
x (D)92mm
Cut-out: (H)225mm x
(W)370mm x (D)68mm
6007328370710



EB34  5
36 Way Din Rail
Plastic
Neutral Bar
Earth Bar
(H)481mm x (W)300mm
x (D)98mm
Cut-out: (H)445mm x
(W)260mm x (D)68mm
6007328370734

Electrical Enclosure

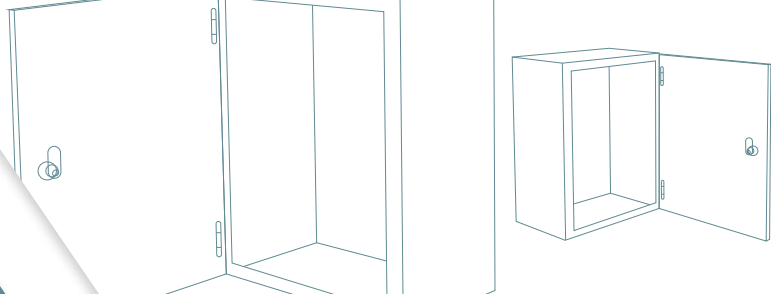

Steel Enclosures

Code	Colour	Fitting Material	IP Rating	H	W	D	Barcode
EC252015	Orange	Steel	66	250mm	200mm	150mm	6007328371113
EC302515	Orange	Steel	66	300mm	250mm	150mm	6007328371120
EC302520	Orange	Steel	66	300mm	250mm	200mm	6007328371144
EC303020	Orange	Steel	66	300mm	300mm	200mm	6007328371151
EC304020	Orange	Steel	66	300mm	400mm	200mm	6007328380849
EC403020	Orange	Steel	66	400mm	300mm	200mm	6007328371175
EC404020	Orange	Steel	66	400mm	400mm	200mm	6007328371182
EC504025	Orange	Steel	66	500mm	400mm	250mm	6007328371250
EC604020	Orange	Steel	66	600mm	400mm	200mm	6007328371236
EC604025	Orange	Steel	66	600mm	400mm	250mm	6007328371274
EC606025	Orange	Steel	66	600mm	600mm	250mm	6007328369516
EC705025	Orange	Steel	66	700mm	500mm	250mm	6007328369530
EC806025	Orange	Steel	66	800mm	600mm	250mm	6007328373513
EC808030	Orange	Steel	66	800mm	800mm	300mm	6007328369479
EC100803	Orange	Steel	66	1000mm	800mm	300mm	6007328373568
EC120803	Orange	Steel	66	1200mm	800mm	300mm	6007328373575

NOTE: Enclosure Doors are Interchangeable

Electrical Enclosure

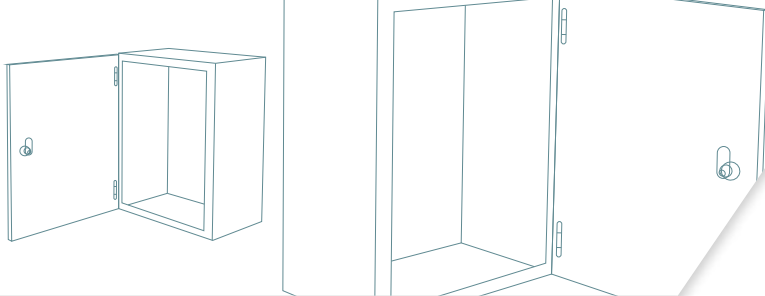

Stainless Steel Enclosures

Code	Colour	Fitting Material	IP Rating	H	W	D	Barcode
EN253015	-	Stainless Steel	66	250mm	300mm	150mm	6007328376095
EN403020	-	Stainless Steel	66	400mm	300mm	200mm	6007328376101
EN406020	-	Stainless Steel	66	400mm	600mm	200mm	6007328376118
EN606025	-	Stainless Steel	66	600mm	600mm	250mm	6007328376125
EN608020	-	Stainless Steel	66	600mm	800mm	200mm	6007328376132
EN801003	-	Stainless Steel	66	800mm	1000mm	300mm	6007328376149

NOTE: Enclosure Doors are Interchangeable

Waterproof Isolators

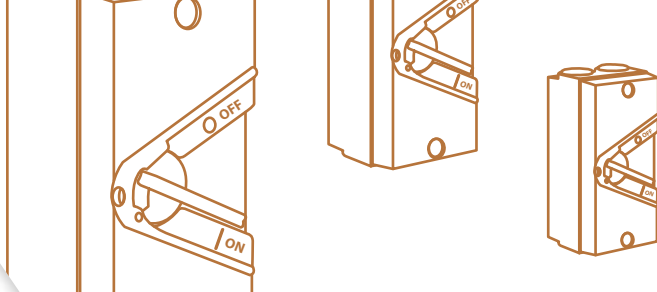

Waterproof Isolators



Code	Rating	Poles	IP Rating	Box Qty.	Barcode
EI1-20	20A	1 Pole	66	20	6007328377412
EI1-35	35A	1 Pole	66	20	6007328377429
EI1-63	63A	1 Pole	66	20	6007328377436
EI2-20	20A	2 Pole	66	20	6007328377443
EI2-35	35A	2 Pole	66	20	6007328377481
EI2-63	63A	2 Pole	66	20	6007328377467
EI3-20	20A	3 Pole	66	20	6007328377474
EI3-35	35A	3 Pole	66	20	6007328377481
EI3-63	63A	3 Pole	66	20	6007328377498
EI4-20	20A	4 Pole	66	20	6007328377504
EI4-35	35A	4 Pole	66	20	6007328377511
EI4-63	63A	4 Pole	66	20	6007328377528

Plug-in Timer & Time Switch

Plug-in Timer 24 Hours



EA68  48
 White
 15min increment adjustment
 3500W / 16Amps
 6007328351337

Time Switch



ETS144K  50
 6007328370284

Rated voltage	220V
Voltage tolerance	220V+15%
Frequency	50/60Hz (selection type)
Power consumption	<3W
Time precision	Same as AC frequency
Ambient temperature	-10°C ~ ± 50°C
Resistive load	220VAC 15A
Lamp load	220VAC 3000W
Inductive load	10A (cos =0.7 or more)
Motor load	220VAC 1500W
Minimum setting until	15 minute units
Minimum setting interval	30 minutes
Number of ON - OFF operations	Standard 4 operations maximum 48 operations are possible

Conduit & Conduit Tools

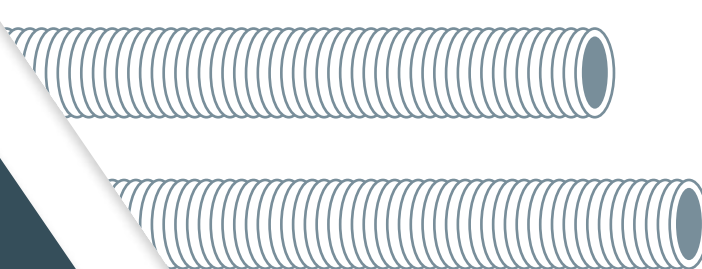

PVC Conduit



EA198  25
20mm PVC Conduit
White
25 Per Bundle
Length: 4m
6007328361541



EA230  25
25mm PVC Conduit
White
25 Per Bundle
Length: 4m
6007328365822



ECO62  10
20mm Flexible PVC Conduit
Grey
Length: 50m Roll
6007328371410



ECO65  10
25mm PVC Flexible Conduit
Grey
Length: 50m Roll
6007328371427

Conduit Tools



20mm

EA221  20
20mm Bending Spring
Steel
Length: 645mm
6007328363002



25mm

EA222  20
25mm Bending Spring
Steel
Length: 645mm
6007328363019



Steel

EA223  10
30m Steel Fish Tape
6007328363026



Nylon

EA224  10
30m Nylon Fish Tape
Diameter: 4mm
6007328363033

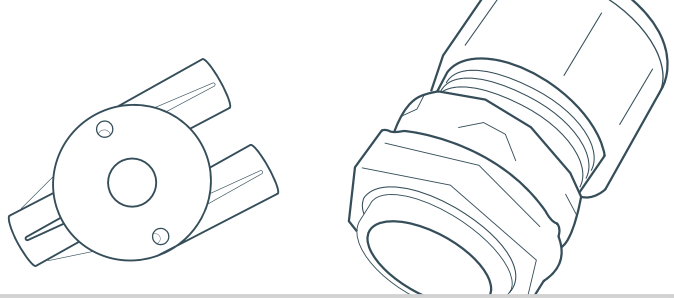

20mm Junction Boxes



EA133  100
Round Self Locating Lid
PVC
Diameter: 66mm
Depth: 2mm
6007328354154



EA125  20
20mm 1 Way
PVC
Diameter: 66mm
Depth: 32mm
6007328354079



EA126  20
20mm 2 Way Through
PVC
Diameter: 66mm
Depth: 32mm
6007328354086



EA127  20
20mm 3 Way
PVC
Diameter: 66mm
Depth: 32mm
6007328354093



EA128  20
20mm 4 Way
PVC
Diameter: 66mm
Depth: 32mm
6007328354109



EA129  20
20mm 8 Way Knock out
PVC
Diameter: 66mm
Depth: 32mm
6007328354116



EA130  20
20mm 2 Way Angle
PVC
Diameter: 66mm
Depth: 32mm
6007328354123



EA131  20
20mm U Box
PVC
Diameter: 66mm
Depth: 32mm
6007328354130



EA132  20
20mm Y Box
PVC
Diameter: 66mm
Depth: 32mm
6007328354147

Conduit Accessories

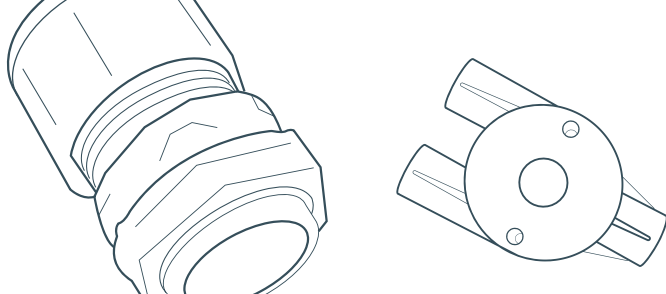

25mm Junction Boxes



EA235  20
25mm 1 Way
PVC
Diameter: 66mm
Depth: 32mm
6007328379430



EA236  20
25mm 2 Way Through
PVC
Diameter: 66mm
Depth: 32mm
6007328379454



EA237  20
25mm 3 Way
PVC
Diameter: 66mm
Depth: 32mm
6007328379478



EA238  20
25mm 4 Way
PVC
Diameter: 66mm
Depth: 32mm
6007328379492

20mm Connectors, Adapters, Couplings & Glands



EA134  100
20mm Male Adapter
PVC
6007328354161



EA139  20
20mm Bend (Long)
PVC
6007328354215



EA139S  65
20mm Bend (Short)
PVC
6007328371434



EA227  600
20mm Universal Gland (0/1)
Nylon
6007328363064



EA135  100
20mm Female Adapter
PVC
6007328354178



EA140  50
20mm Coupling
PVC
6007328354222



EA69  100
20mm Universal Gland (0/1)
PVC
6007328351344

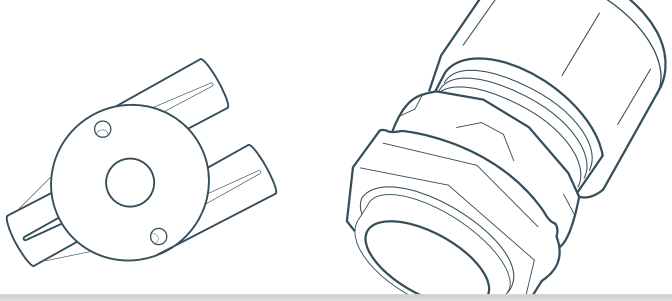

25mm/30mm Connectors, Adapters, Couplings



EA239  20
PVC Bend (Long)
25mm
6007328379515



EA240  50
PVC Male Adaptor
25mm
6007328379539



EA243  50
PVC Coupling
25mm
6007328379591



EA241  20
PVC Coupling
32mm
6007328379553

Conduit Accessories

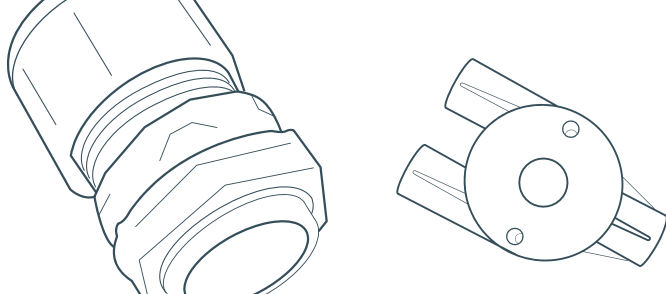

Saddles



EA165  50
20mm Hospital Saddle
Galvanised Steel / Aluminium
6007328356479



EA166  25
25mm Hospital Saddle
Galvanised Steel / Aluminium
6007328356486



EA244  60
32mm Hospital Saddle
Galvanised Steel / Aluminium
6007328383420



EA141  100
20mm Strap Saddle
PVC
6007328354239



EA242  20
PVC Strap Saddle 25MM
6007328379577



Galvanised Steel Saddle

Code	Thread	Box Qty.	Barcode
EA215	16mm	400	6007328363897
EA159	20mm	300	6007328355700
EA160	25mm	200	6007328355717
EA218	32mm	100	6007328363927
EA219	40mm	50	6007328363934
EA220	50mm	50	6007328363941

Locknuts

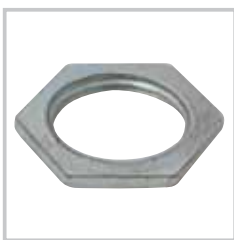

Steel Locknut

Code	Thread	Box Qty.	Barcode
EA200	20mm	100	6007328363743
EA201	25mm	100	6007328363750
EA202	32mm	100	6007328363767
EA203	40mm	50	6007328363774
EA204	50mm	50	6007328363781

Bushes



Short Brass Male Bush

Code	Thread	Box Qty.	Barcode
EA205	20mm	100	6007328363798
EA206	25mm	100	6007328363804
EA207	32mm	100	6007328363811
EA208	40mm	25	6007328363828
EA209	50mm	25	6007328363835



Brass Female Bush

Code	Thread	Box Qty.	Barcode
EA210	20mm	100	6007328363842
EA211	25mm	100	6007328363859
EA212	32mm	100	6007328363866
EA213	40mm	50	6007328363873
EA214	50mm	25	6007328363880

Wall, Weatherproof Extension Boxes

Wall Boxes



EA118  150
4 x 2
PVC
Height: 60mm
Width: 104mm
Depth: 47mm
6007328354000



EA119  100
4 x 4
PVC
Height: 105mm
Width: 105mm
Depth: 47mm
6007328354017



EA161  240
4 x 2
Galvanised Steel
Height: 106mm
Width: 68mm
Depth: 43mm
6007328355724



EA162  120
4 x 4
Galvanised Steel
Height: 105mm
Width: 105mm
Depth: 43mm
6007328355731

Extension Boxes



EA116  100
4 x 2
PVC
Height: 128mm
Width: 84mm
Depth: 46mm
6007328353980



EA117  70
4 x 4
PVC
Height: 128mm
Width: 128mm
Depth: 46mm
6007328353997



EA171  120
4 x 2
Steel
Height: 130mm
Width: 86mm
Depth: 39mm
6007328358794



EA172  90
4 x 4
Steel
Height: 130mm
Width: 130mm
Depth: 39mm
6007328358800

• **EA163** 6 pack 6007328355748

• **EA164** 6 pack 6007328355755

Weatherproof Boxes



EA194  24
4 x 2
Fibreglass
Height: 102mm
Width: 154mm
Depth: 79mm
6007328361206



EA195  12
4 x 4
Fibreglass
Height: 145mm
Width: 153mm
Depth: 80mm
6007328361213



EA143  25
PVC
Bonding Fluid
200ml
6007328354253

Magnetic Ballast

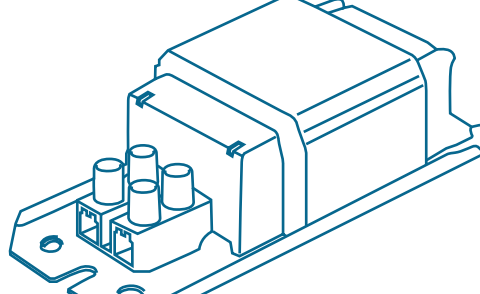

PL Ballasts

Electromagnetic ballasts for single ended 2-pin PL lamps.

Code	Output Wattage	Current	Power Factor	Microfarad	Temperature	Length	Width	Height	Weight	Box Qty.	Barcode
CO02	1 x 7W	0,160A	0,45	2,5µF	tw 130°C / Δ55°C	95mm	41mm	28mm	0.32kg	40	6007328329350
	1 x 9W	0,170A	0,35								
	1 x 11W	0,175A	0,25								
CO11	1 x 13W	0,175A	0,47	2µF	tw 130°C / Δ55°C	95mm	41mm	28mm	0.32kg	40	6007328349341
CO03	1 x 18W	0,22A	0,49	2,5µF	tw 130°C / Δ60°C	95mm	41mm	28mm	0.32kg	40	6007328329367
CO05	1 x 26W	0,325A	0,49	3,5µF	tw 130°C / Δ60°C	110mm	41mm	28mm	0.44kg	40	6007328349358



T8 Fluorescent Ballasts

Electromagnetic ballasts for double ended linear or circline fluorescent lamps.

Code	Output Wattage	Current	Power Factor	Microfarad	Temperature	Length	Width	Height	Weight	Box Qty.	Barcode
CO04	2 x 18W	0,43A	0,46	4,5µF	tw 130°C / Δ60°C	150mm	41mm	30mm	0.55kg	30	6007328329374
	2 x 20W	0,37A	0,48			150mm					
	1 x 36W	0,43A	0,46			55mm					
	1 x 40W	0,43A	0,50			55mm					
CO06	2 x 15W	0,33A	0,46	4,5µF	tw 130°C / Δ60°C	150mm	41mm	30mm	0.55kg	30	6007328349372
CO07	1 x 18W	0,37A	0,33	4,5µF	tw 130°C / Δ60°C	155mm	41mm	28mm	0.55kg	30	6007328349365
	1 x 20W	0,37A	0,35								
CO09	1 x 58W	0,67A	0,46	7µF	tw 130°C / Δ65°C	195mm	41mm	28mm	0.92kg	20	6007328001140
	1 x 65W	0,67A	0,50								

Electronic Ballast Fluorescent Multiple Lamps

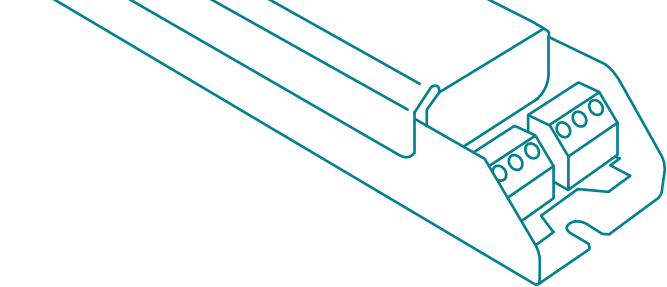

Electronic Ballast for 3 or 4 Fluorescent Lamps T8/TC-L/T5

Code	Power	Current	Power Factor	Max Temp. at TC point	Operating Temp.	Format	Units per Box	Index	Barcode
	(W)	(A)	(λ)	°C	°C			EEL	

3 Lamp Ballast

ELTEB24	T8 18W TC-L 18W TC-L 24W T5 - HO 24W	0,355	0,97	70	-20 - 55	1	24	A2	6007328366584
---------	---	-------	------	----	----------	---	----	----	---------------



Electronic Ballast for 3 or 4 Fluorescent Lamps T5-HE 14W

Code	Power	Current	Power Factor	Max Temp. at TC point	Operating Temp.	Units per Box	Index	Barcode
	(W)	(A)	(λ)	°C	°C		EEL	

3 or 4 Lamp Ballast

ELTEB23	T5-HE 3x 4x 14W	0,21 - 0,285	0,97	70	-20 - 55	24	A2	6007328366577
---------	-----------------	--------------	------	----	----------	----	----	---------------



Electronic Ballast for 1 or 2 Fluorescent Lamps T5

Code	Power	Current	Power Factor	Max Temp. at TC point	Operating Temp.	Units per Box	Index	Barcode
	(W)	(A)	(λ)	°C	°C		EEL	

1 Lamp Ballasts

ELTEB21	T5 HO 1x 80W	0,38	0,95	70	-20 - 50	24	A2	6007328366553
---------	--------------	------	------	----	----------	----	----	---------------

1 or 2 Lamps Ballasts

ELTEB25	T5 HE 1x 2x 14, 21, 28W T5 HE 1x 35W	0,07 - 0,29	0,94	70	-20 - 50	24	A2	6007328366591
---------	---	-------------	------	----	----------	----	----	---------------

Electronic Ballast Fluorescent Multiple Lamps

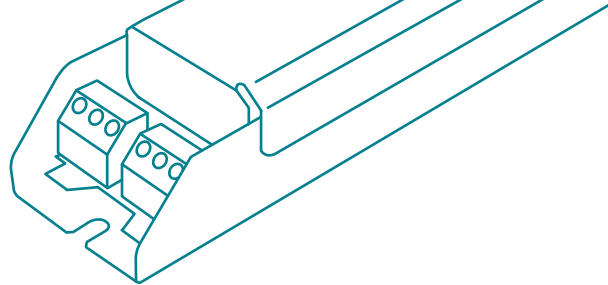

Electronic Ballast for 1 or 2 Fluorescent Lamps T8/TC-L/T5

Code	Power (W)	Current (A)	Power Factor (λ)	Max Temp. at TC point °C	Operating Temp. °C	Units per Box	Index EEI	Barcode
1 Lamp Ballasts								
ELTEB13	T8 18, 30, 36W TC-L 18, 36W T5 24, 39W	0,09 - 0,19	0,95	70	-20 - 50	24	A2	6007328366478
ELTEB14	T8 58W TC-L 55W T5 54W	0,24 - 0,27	0,95	70	-20 - 50	24	A2	6007328366485
1 or 2 Lamp Ballasts								
ELTEB3	T8 1x 2x 18, 36W	0,17 - 0,31	0,98	75	-25 - 55	24	A2	6007328377979
ELTEB29	T8 1x 2x 58W TC-L 1x 2x 55W T5 1x 2x 54W	0,24 - 0,48	0,98	70	-20 - 50	24	A2	6007328370956
ELTEB4	T8 1x 2x 58W	0,48	0,98	75	-25 - 55	24	A2	6007328366386

Electronic Ballast Fluorescent & PL Multiple Lamps



Electronic Ballast for 1 or 2 Fluorescent Lamps T8

Code	Power (W)	Current (A)	Power Factor (λ)	Max Temp. at TC point °C	Operating Temp. °C	Units per Box	Index EEI	Barcode
------	--------------	----------------	---------------------	--------------------------------	--------------------------	---------------	--------------	---------

1 Lamp Ballast

ELTEB1	18,36	0,095 - 0,165	0,97	75	-25 - 55	24	A2	6007328366355
ELTEB2	58	0,25	0,97	75	-25 - 55	24	A2	6007328377962
ELTEB3	1x 2x 18,36	0,17-0,31	0,98	75	-25 - 55	24	A2	6007328366379
ELTEB4	1x 2x 58	0,48	0,98	75	-25 - 55	24	A2	6007328366386



Electronic Ballast for 1 or 2 Compact Lamps

Code	Power (W)	Current (A)	Power Factor (λ)		Max Temp. at TC point °C	Operating Temp. °C	Units per Box	Index EEI	Barcode
			1 x lamp	1 x lamp					

ELTEB5	TC-DE 2x 13 TC-TE 1x 13 TC-SE 2x 7,9,11 TC-SE 1x 7,9,11 TC-DD 1x 16	0,04 - 0,13	0,87	0,97	75	-20 - 50	30	A2	6007328366393
ELTEB6	TC-DE 2x 18 TC-TE 1x 18	0,09 - 0,17	0,87	0,97	75	-20 - 50	30	A2	6007328366409
ELTEB7	TC-DE 2x 26 TC-TE 1x 26,32,42 TC-L 2x 18,24 TC-F 1x 18,24,36, 40 T5C 2x 22 T5C 1x 22, 40	0,08 - 0,23	0,87	0,97	75	-20 - 50	30	A5	6007328366416



Electronic Ballast for 3 or 4 Fluorescent Lamps T8/TC-L/T5

Code	Power (W)	Current (A)	Power Factor (λ)	Max Temp. at TC point °C	Operating Temp. °C	Units per Box	Index EEI	Barcode
------	--------------	----------------	---------------------	--------------------------------	--------------------------	------------------	--------------	---------

3 or 4 Lamp Ballast

ELTEB16	T8 3x4x 18,30,36W TC-L 3x4x 18,36W T5 3x4x 24W T5 3x 39W	0,25 - 0,63	0,98	70	-20 - 50	18	A2	6007328366508
---------	---	-------------	------	----	----------	----	----	---------------

Electronic Ballast Fluorescent

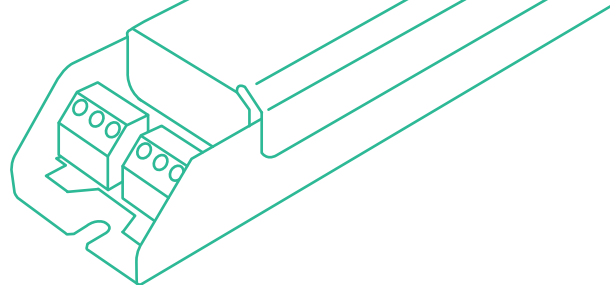

Electronic Ballast for 1, 2, Fluorescent Lamps T8 Universal



Code	Power (W)	Voltage DC/AC (V)	Current (A)		Power Factor (λ)	Max Temp. at TC point (°C)	Operating Temp. (°C)	Units per Box	Index EEI	Barcode
			110V	230V						

1 or 2 Lamp Ballasts

ELTEB11	36	110 - 240	0,17 - 0,33	0,088 - 0,18	0,98	70	-25 - 55	24	A2	6007328366454
ELTEB12	58	110 - 240	0,17 - 0,33	0,088 - 0,18	0,98	70	-25 - 55	24	A2	6007328366461



Electronic Super Slim Ballast for 1 or 2 Fluorescent Lamps T5-HE and T5-HO

Code	Power (W)	Voltage DC V ± 10%	Current (A)	Power Factor (λ)	Max Temp. at TC point (°C)	Operating Temp. (°C)	Units per Box	Index EEI	Barcode
------	--------------	--------------------------	----------------	---------------------	----------------------------------	----------------------------	------------------	--------------	---------

1 Lamp Ballast

ELTEB17	14, 21, 18, 35W	220 - 240	0,078 - 0,172	0,97	70	-20 - 55	28	A2	6007328366515
ELTEB18	49W	220 - 240	0,24	0,98	70	-20 - 55	28	A2	6007328366522
ELTEB19	54W	220 - 240	0,26	0,98	70	-20 - 55	28	A2	6007328366539
ELTEB21	80W	220 - 240	0,38	0,98	70	-20 - 50	28	A2	6007328366553

2 Lamp Ballast

ELTEB20	14, 21, 18, 35W	220 - 240	0,15 - 0,34	0,98	70	-20 - 55	28	A2	6007328366546
---------	-----------------	-----------	-------------	------	----	----------	----	----	---------------



Constant Current control gears for LED modules up to 50W

Code	Output Power (W)	Output Current (mA)	Output Volt- age Range (V)	Power Factor (λ)	System Efficiency (%)	Max Temp. at tc Point (°C)	Operating Temp. (°C)	Barcode
ELTLD18	24 - 50	700	34 - 72	0,98	89	75	-20 - 50	6007328367291

Electronic Ballast Fluorescent

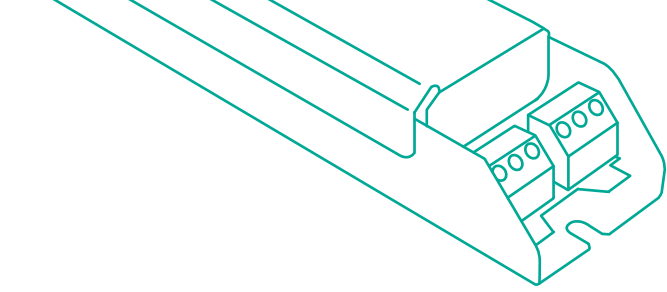

Electronic Ballast for 3 or 4 Fluorescent Lamps T8/TC-L 18W

Code	Power (W)	Current (A)	Power Factor (λ)	Max Temp. at TC point °C	Operating Temp. °C	Units per Box	Index EEI	Barcode
------	--------------	----------------	---------------------	--------------------------------	--------------------------	---------------	--------------	---------

3 or 4 Lamp Ballast

ELTEB15	T8 3x 4x 18W TC-L 3x 4x 18W	0,325	0,98	70	-20 - 55	24	A2	6007328366492
---------	--------------------------------	-------	------	----	----------	----	----	---------------



Emergency Lighting Kits with Self-diagnosis for 6 to 80W Fluorescent Lamps

Code	Model	Battery			Kit	Barcode
		Dimensions L x D mm	Nominal Performance h	Operatng Temp. °C		

Inverter and Battery

ELTEL2	4,8V 1,8Ah NiCd	175 x 22	1	5 - 50	0,420	6007328373018
--------	-----------------	----------	---	--------	-------	---------------



Emergency Lighting Kits with Self-diagnosis Function for constant current LED Luminaires

Inverter and Battery

Code	Operating Voltages Under Normal Conditions	LED Module Not Connected or Defective	Battery Included	Nominal Performance	Operatng Temp.	Set Weight	Barcode
------	---	--	---------------------	------------------------	-------------------	---------------	---------

ELTEL1	min. 30V / max 220V	max 250V	4,8V 1,8Ah NiCd	1 hour	5 - 50°C	0,343Kg	6007328373001
--------	---------------------	----------	-----------------	--------	----------	---------	---------------

Magnetic HID Ballasts

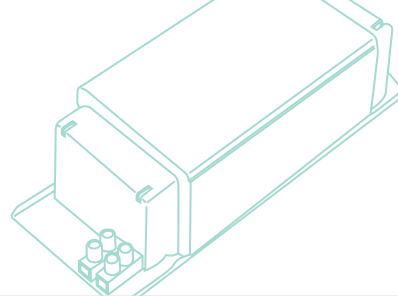

High Pressure Sodium Ballasts

Code	Lamp		Capacitor	Ballast						
	Output Wattage	Current	Microfarad	Temperature	Length	Width	Height	Weight	Box Qty.	Barcode
CO140	70W	1.00A	12 μ F	tw 130°C / Δ 65°C	112mm	66mm	53mm	1.21kg	10	6007328349389
CO141	150W	1.80A	20 μ F	tw 130°C / Δ 70°C	145mm	66mm	53mm	2.1kg	10	6007328349396
CO142	250W	3.00A	32 μ F	tw 130°C / Δ 80°C	180mm	68mm	55mm	2.9kg	6	6007328349402
CO117	400W	4.45A	45 μ F	tw 130°C / Δ 80°C	150mm	105mm	95mm	4.5kg	4	6007328349471
CO143	600W	6.2A	65 μ F	tw 130°C / Δ 80°C	173mm	102mm	91mm	6.4kg	2	6007328349419



Metal Halide Ballasts

Code	Lamp		Capacitor	Ballast						
	Output Wattage	Current	Microfarad	Temperature	Length	Width	Height	Weight	Box Qty.	Barcode
CO140	70W	1.00A	12 μ F	tw 130°C / Δ 65°C	112mm	66mm	53mm	1.21kg	10	6007328349389
CO141	150W	1.80A	20 μ F	tw 130°C / Δ 70°C	145mm	66mm	53mm	2.1kg	10	6007328349396
CO144	200W	1.80A	14 μ F	tw 130°C / Δ 70°C	145mm	66mm	53mm	2kg	10	6007328349334



Mercury Vapour Ballasts

Code	Lamp		Capacitor	Ballast						
	Output Wattage	Current	Microfarad	Temperature	Length	Width	Height	Weight	Box Qty.	Barcode
CO145	80W	0.80A	8 μ F	tw 130°C / Δ 65°C	112mm	66mm	53mm	0.95kg	10	6007328349433
CO146	125W	1.15A	12 μ F	tw 130°C / Δ 70°C	112mm	66mm	53mm	1.21kg	10	6007328349440
CO147	250W	2.13A	18 μ F	tw 130°C / Δ 75°C	148mm	66mm	53mm	2.1kg	10	6007328349457
CO57	400W	3.25A	30 μ F	tw 130°C / Δ 80°C	180mm	105mm	95mm	2.9kg	4	6007328349464

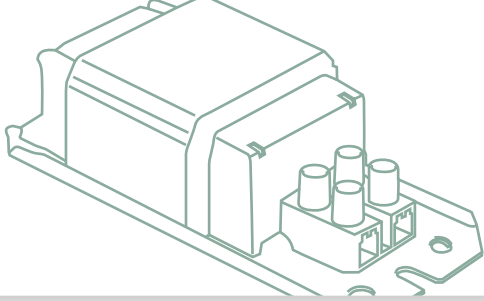

Ignitors & Capacitors



AVS 400-D Ignitor for HPS. MH

Code	Lamp	Switch-on Voltage	Switch-off Voltage	Main Voltage	Peak Voltage	Impulse width at	Pulse No. per Cycle	Impulse Position	Load Capacitance	Losses at 4,6A	Max Temp. at tc Point	Minimum ambient Temp.	Barcode
		V	V	V	kV	2,5kV sec	No.	°e	pF	W	°C	°C	
ELT11	Na 70(DE) - 100, 150, 250, 400W Hgl 35 - 400W	≥198	>170	198 ÷ 264	3,5 ÷ 5	≥ 0,6	6	60 - 90 240 - 270	150	2,6	105	-30	6007328366614

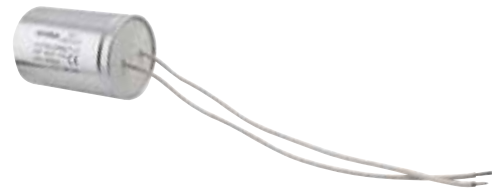

Capacitors for Power Factor Correction

Code	Type of Capacitor			Dimensions		Weight	Units per Box	Barcode
	Capacity	Tolerance	Voltage					
	µF	±%	V	Ø mm	L mm	Kg		
CO18	45	5	250	45	100	0,140	32	6007328389842



High Pressure Sodium / Metal Halide Gears

Complete gears including electromagnetic ballast, ignitor and capacitor.

Code	Lamp		Capacitor	Ballast					Barcode
	Output Wattage	Current	Microfarad	Temperature	Length	Width	Height	Box Qty.	
CO80	70W	1.0A	12µF	tw 130°C / Δ70°C	207mm	124mm	83mm	8	6007328334088
CO81	150W	1.8A	20µF	tw 130°C / Δ70°C	207mm	124mm	83mm	8	6007328336136

Electronic Control Gear HID

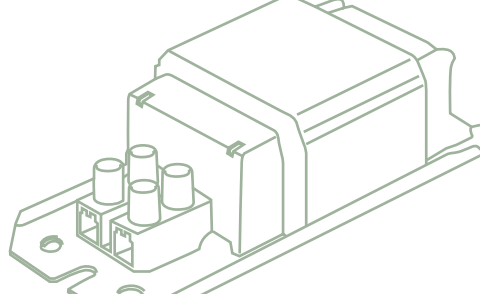

Electronic Ballast for Metal Halide Lamps - Ignition Voltage 5kV

Code	Lamp	Operating Frequency	Current	Ignition Voltage	Max Cable Length to Lamp	Power Factor	Max Temp at tc Point	Operating Temp.	Cable Section	Units per Box	Barcode
	(W)	(Hz)	(A)	(Kv)	(m)	(λ)	(°C)	(°C)	(mm ²)		
ELTEB26	70W HID	135	0,11	5	2	0,95	80	-20 - 55	0,75 - 2,5	20	6007328366607



Electronic Ballast for Metal Halide Lamps

Code	Lamp	Operating Frequency	Current	Ignition Voltage	Power Factor	Max Temp at tc Point	Operating Temp.	Units per Box	Index	Barcode
	(W)	(Hz)	(A)	(Kv)	(λ)	(°C)	(°C)		EEL	
ELTEB27	70W MH	200/240	0,36	4,5	>0,95	85	-25 - 55	20	A2	6007328367000
ELTEB30	150W MH	165/165	0,72	4,5	>0,95	85	-25 - 55	20	A2	6007328382744
ELTEB28	150W MH	165	0,72	4,5	>0,95	75	-25 - 50	20	A2	6007328367086

LED Modules



LED Modules eLED Square 2 1900

Code	Power in Module (W)	Maximum Current (mA)	Voltage Range (V)	Colour Temp. (K)	Luminous Flux at 25°C (lm)	Luminous efficacy (lm/W)	CRI	Max Temp. at tc Point (°C)	Operating Temp. (°C)	Max Temp. in the Junction (°C)	Units per Box	Barcode
------	------------------------	-------------------------	----------------------	---------------------	-------------------------------	-----------------------------	-----	-------------------------------	-------------------------	-----------------------------------	---------------	---------

Operating Mode at 700mA

ELTLM19	12,3	700	16,2 - 18	3000	1750	143	>80	75	-40 - 55	110	30	6007328366973
ELTLM20	12,3	700	16,2 - 18	4000	1900	155	>80	75	-40 - 55	110	30	6007328366980

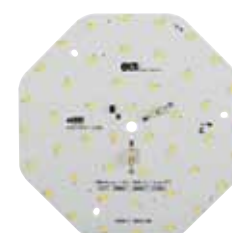

LED Modules eLED OCTO 12550

Code	Power in Module (W)	Maximum Current (mA)	Voltage Range (V)	Colour Temp. (K)	Luminous Flux at 25°C (lm)	Luminous efficacy (lm/W)	CRI	Max Temp. at tc Point (°C)	Operating Temp. (°C)	Max Temp. in the Junction (°C)	Units per Box	Barcode
------	------------------------	-------------------------	----------------------	---------------------	-------------------------------	-----------------------------	-----	-------------------------------	-------------------------	-----------------------------------	---------------	---------

Operating Mode at 700mA

ELTLM16	19,5	700	26,1 - 28,8	3000	2350	121	>80	75	-40 - 55	110	30	6007328366942
ELTLM17	19,5	700	26,1 - 28,8	4000	2550	131	>80	75	-40 - 55	110	30	6007328366959

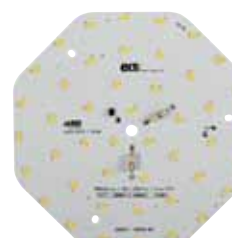

LED Modules eLED OCTO 12150

Code	Power in Module (W)	Maximum Current (mA)	Voltage Range (V)	Colour Temp. (K)	Luminous Flux at 25°C (lm)	Luminous efficacy (lm/W)	CRI	Max Temp. at tc Point (°C)	Operating Temp. (°C)	Max Temp. in the Junction (°C)	Units per Box	Barcode
------	------------------------	-------------------------	----------------------	---------------------	-------------------------------	-----------------------------	-----	-------------------------------	-------------------------	-----------------------------------	---------------	---------

Operating Mode at 700mA

ELTLM13	15	700	20,3 - 22,4	3000	2000	134	>80	75	-40 - 55	110	30	6007328366911
ELTLM14	15	700	20,3 - 22,4	4000	2150	143	>80	75	-40 - 55	110	30	6007328366928

LED Modules

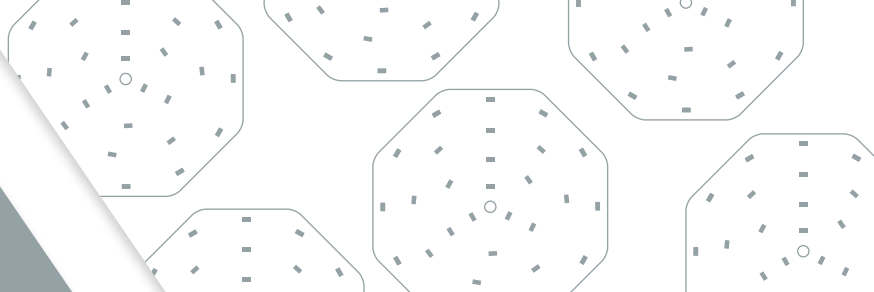

LED Modules eLED Line 1950

Code	Power in Module	Maximum Current	Voltage Range	Colour Temp.	Luminous Flux at 25°C	Luminous efficacy	CRI	Max Temp. at tc Point	Operating Temp.	Max Temp. in the Junction	Units per Box	Barcode
	(W)	(mA)	(V)	(K)	(lm)	(lm/W)		°C	°C	°C		
ELTLM7	12,8	700	17,4 - 19,2	3000	1750	137	>80	75	-40 - 55	110	60	6007328366850
ELTLM8	12,8	700	17,4 - 19,2	4000	1900	148	>80	75	-40 - 55	110	60	6007328366867



LED Modules eLED Line 1950

Code	Power in Module	Maximum Current	Voltage Range	Colour Temp.	Luminous Flux at 25°C	Luminous efficacy	CRI	Max Temp. at tc Point	Operating Temp.	Max Temp. in the Junction	Units per Box	Barcode
	(W)	(mA)	(V)	(K)	(lm)	(lm/W)		°C	°C	°C		

Operating Mode at 700mA

ELTLM1	6,4	700	8,7 - 9,6	3000	875	137	>80	75	-40 - 55	110	120	6007328366799
ELTLM2	6,4	700	8,7 - 9,6	4000	950	148	>80	75	-40 - 55	110	120	6007328366805



LED Modules eLED Line 11250

Code	Power in Module	Maximum Current	Voltage Range	Colour Temp.	Luminous Flux at 25°C	Luminous efficacy	CRI	Max Temp. at tc Point	Operating Temp.	Max Temp. in the Junction	Units per Box	Barcode
	(W)	(mA)	(V)	(K)	(lm)	(lm/W)		°C	°C	°C		

Operating Mode at 700mA

ELTLM4	8,5	700	11,6 - 12,8	3000	1150	135	>80	75	-40 - 55	110	80	6007328366829
ELTLM5	8,5	700	11,6 - 12,8	4000	1250	146	>80	75	-40 - 55	110	80	6007328366836

LED Modules



LED Modules eLED Line 22500

Code	Power in Module (W)	Maximum Current (mA)	Voltage Range (V)	Colour Temp. (K)	Luminous Flux at 25°C (lm)	Luminous efficacy (lm/W)	CRI	Max Temp. at tc Point (°C)	Operating Temp. (°C)	Max Temp. in the Junction (°C)	Units per Box	Barcode
ELTLM10	17,1	700	23,2 - 25,6	3000	2300	135	>80	75	-40 - 55	110	40	6007328366881
ELTLM11	17,1	700	23,2 - 25,6	4000	2500	146	>80	75	-40 - 55	110	40	6007328366898



LED Modules eLED Line 31000

Code	Dimensions (mm)	Typical Power in Module (W)	Maximum Current (mA)	Typical Voltage Range (V)	Colour Temp. (K)	Luminous Flux at Amb. Temp. 25°C (lm)	Luminous Efficacy (lm/W)	CRI	Max Temp. at tc Point (°C)	Operating Temp. (°C)	Max Temp. in the Junction (°C)	Units per Box	Barcode
ELTLM22	100 x 10	1,5	500	2,9 - 3,2	3000	210	138	>80	75	-40 - 50	110	200	600732883550
	500 x 10	7,6	500	14,5 - 16	3000	1050	138	>80	75	-40 - 50	110	200	

LED Constant Current Drivers

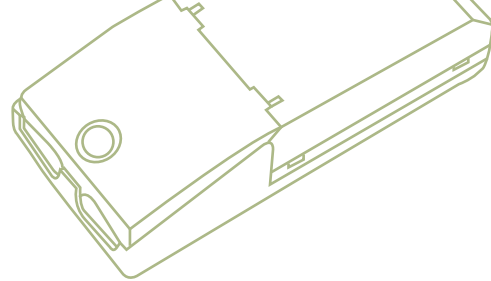

Constant Current Control Gears for LED Modules up to 11W

Code	Output Power	Output Current	Output Voltage Range	Power Factor	System Efficiency	Max Temp. at tc Point	Operating Temp.	Barcode
	(W)	(mA)	(V)	(λ)	%	°C	°C	

Standard Control Gears

ELTLD1	3 - 10	350	9 - 31	0,97	80	75	-25 - 50	6007328366621
ELTLD2	4 - 10,5	500	9 - 21	0,97	80	80	-25 - 50	6007328366638
ELTLD3	4 - 10	700	6 - 16	0,98	80	75	-25 - 50	6007328366645

Leading-edge and Trailing-edge Dimmable Control Gears

ELTLD5	3 - 10	350	9 - 31	0,97	80	85	-25 - 50	6007328366669
ELTLD6	4 - 10	700	6 - 16	0,98	80	80	-25 - 50	6007328366676
ELTLD22	4 - 10,5	500	9 - 21	0,97	80	85	-25 - 50	6007328380559



Constant Current Control Gears for LED Modules up to 90W

Code	Output Power	Output Current	Output Voltage Range	Power Factor	System Efficiency	Max Temp. at tc Point	Operating Temp.	Barcode
	(W)	(mA)	(V)	(λ)	%	°C	°C	

ELTLD14	23 - 50	350	66 - 143	0,98	90	75	-20 - 55	6007328366751
ELTLD15	23 - 50	500	46 - 100	0,98	90	75	-20 - 55	6007328366768
ELTLD16	24 - 50	700	34 - 72	0,98	89	75	-20 - 55	6007328366775
ELTLD17	40 - 90	700	58 - 129	0,98	91	75	-20 - 50	6007328366782

LED Constant Current Drivers

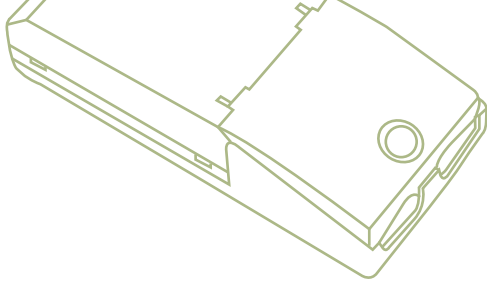

Constant Current Control Gears for LED Modules up to 11W

Code	Output Power	Output Current	Output Voltage Range	Power Factor	System Efficiency	Max Temp. at tc Point	Operating Temp.	Barcode
	(W)	(mA)	(V)	(λ)	%	°C	°C	

Leading-edge and Trailing-edge Dimmable Control Gears

ELTLD5	3 - 10	350	9 - 31	0,97	80	85	-25 - 50	6007328366669
ELTLD6	4 - 10	700	6 - 16	0,98	80	80	-25 - 50	6007328366676
ELTLD22	4 - 10,5	500	9 - 21	0,97	80	85	-25 - 50	6007328380559



Dali Dimmable Constant Current Control Gears for LED Modules up to 90W

Code	Output Power	Output Current	Output Voltage Range	Power Factor	System Efficiency	Max Temp. at tc Point	Operating Temp.	Barcode
	(W)	(mA)	(V)	(λ)	%	°C	°C	

ELTLD20	45 - 90	700	64 - 129	0,98	91	75	-20 - 50	6007328373032
ELTLD21	33,5 - 50	700	48 - 72	0,98	89	75	-20 - 55	6007328378051



Dimmable Constant Current Control Gears for LED Modules up to 25W

Code	Output Power	Output Current	Output Voltage Range	Power Factor	System Efficiency	Max Temp. at tc Point	Operating Temp.	Barcode
	(W)	(mA)	(V)	(λ)	%	°C	°C	

ELTLD19	16 - 25	350	45 - 72	0,93	85	75	-25 - 50	6007328372844
ELTLD23	16 - 25	500	32 - 50	0,94	85	85	-25 - 50	6007328380566
ELTLD24	16 - 25	700	23 - 37	0,91	85	80	-25 - 50	6007328380573

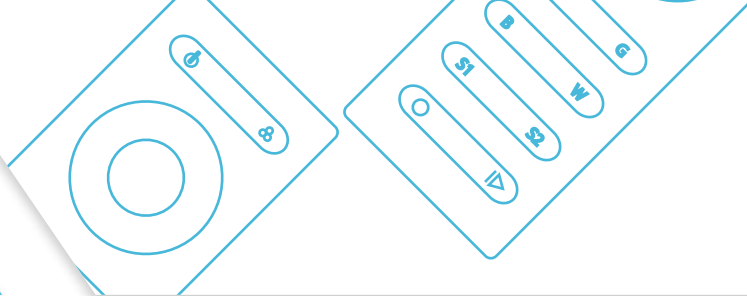

Bluetooth Smart Wireless Control Device for Lighting Control Gears

Code	Input Voltage	Max Current	Voltage Range	Maximum Sink/Source Current	Bus Voltage	Shortcut Current	Max. Number of Drivers Connected	Operating Frequencies	Max Temp. at tc Point	Operating Temp.	Barcode
	(V)	(A)	Vdc	mA	Vdc	mA	(pcs)	(GHz)	tc (°C)	(°C)	
ELTDM1	220 - 240	0,6	0-10	7	9-12	7	1	2,4 - 2,483	70	-20 - 50	6007328377955



Bluetooth Smart Wireless Control Trailing Edge Dimmer

Code	Input Voltage	Max Current	High Voltage Halogen Lamps		AC Dimmable LED Modules		High Quality Dimmable LED Bulbs	High Quality Dimmable CFL Bulbs	Trailing Edge Dimmable LED Drivers	Max Case Temp.	Operating Temp.	Barcode
			(W)		(W)							
			110 Vac	230 Vac	110 Vac	230 Vac						
ELTDM2	85 - 240	0,65	70	150	70	150	50	50	50	65	-20 - 45	6007328377962



Bluetooth Dimmable Constant Current Control Gears for LED Modules up to 50W

Code	Output Currents					Output Voltage Range	Power Factor	System Efficiency	Operating Frequencies	Max Temp. at tc Point	Operating Temp.	Barcode
	(mA)	(mA)	(mA)	(mA)	(mA)	(Vdc)	(λ)	(%)	GHz	(°C)	(°C)	
ELTDM3	250	275	300	325	350	75 - 143	0,89	89	2,4 - 2,483	75	-20 - 50	6007328377979
ELTDM4	400	425	450	475	500	57 - 100	0,97	88	2,4 - 2,483	75	-20 - 50	6007328377986
ELTDM5	600	625	650	675	700	40 - 72	0,97	87	2,4 - 2,483	75	-20 - 45	6007328377993



LED Controllers from the Pro System

Code	Input/Output Voltage	Control Signal	Max Output Current (A)	Max Output Power		LED Strip Type	Barcode
	(V)			12V	24V		
DIM-TW LED Controller							
ELTDM6	12 - 24	PWM	3 x 5A DIM 2 x 5A TW	60W CH	120W CH	Monocolor (1CH - DIM) TW (2CH)	6007328378006
RGB-W-C01 LED Controller							
ELTDM7	12 - 24	PWM	3 x 5A RGB 4 x 5A RGBW	60W CH	120W CH	RGB (3CH) RGBW (4CH)	6007328378013



PRO System DIM Remote Control for the Pro System

Code	Powered by	Operation Frequency	LED Strip Type	Max Range Indoors	Barcode
		Mhz		m	
ELTDM8	3 x AAA / LR03 1,5V batteries	434/869	TW (2CH) DIM / Monocolor (1CH)	20	6007328378020



RGB & RGBW Remote Control for the Pro System

Code	Powered By	Operation Frequency	LED Strip Type	Max Range Indoor (Without Walls)	Barcode
		Mhz		m	
ELTRC1	3 x AAA/LR03 1,5V batteries	434/869	RGB, RGB-W (3CH/4CH)	20	6007328380757

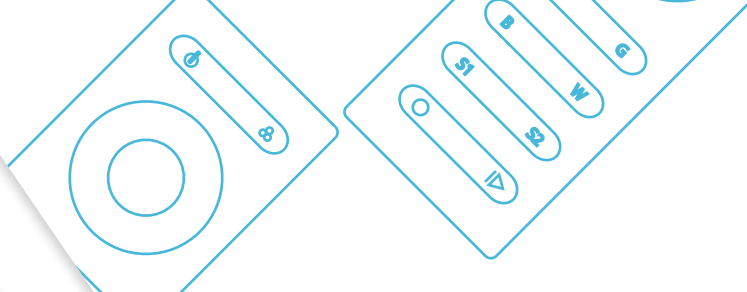

Wall-mounted Touch LED Controller

Code	Input / Output Voltage	Control Signal	Max Output Current (A)	Max Output Power		LED Strip Type	Controls made by	Barcode
	(V)			(W)				
				12V	24V			
ELTTS1	12 - 24	PWM	4 x 5	240	480	TW (2CH)	Touch Panel	6007328378037
ELTTS2	12 - 24	PWM	4 x 5	240	480	RGB (3CH) RGBW (4CH)	Touch Panel	6007328378044
ELTTS3	12 - 24	PWM	4 x 5	240	480	MONOC. DIM (1CH)	Touch Panel	6007328380764



DALI Decoders, 1 DALI address, 4 Channels

Code	Input/Output Voltage	Control Signal	Max Output Current	Max Output Power			LED Strip Type	Barcode
	V			12V	24V	36V		
ELTDALMULTI	12-24-36	PWM	4ch x 5A	240W (4 x 60)	480W (4 x 120)	720W (4x180)	DIM	6007328383352

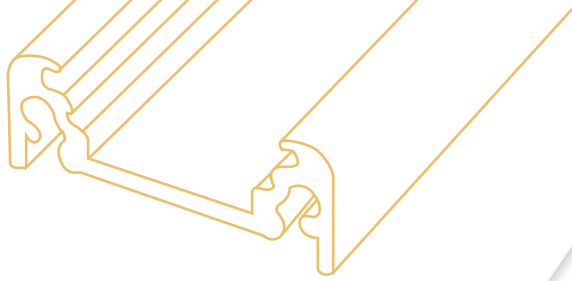

Aluminium Profile

G53 EMP Aluminium Profile for LED strips



ELTSP5  1
 For LED Strips
 up to 1x 20mm,
 2 x 12mm, 2 x 10mm
 Installation: Recessed
 Colour: Anodized
 6007328383697



ELTSP7  1
 For LED Strips
 up to 1x 20mm,
 2 x 12mm, 2 x 10mm
 Installation: Recessed
 Colour: Opal
 6007328383710



ELTSP6  1
 For LED Strips
 up to 1x 20mm,
 2 x 12mm, 2 x 10mm
 Endings
 Colour: Silver
 6007328383703

SUP Aluminium Profile for LED strips



ELTSP1  1
 For LED Strips
 up to 10mm
 Installation: Surface
 Colour: Anodized
 600732883567



ELTSP3  1
 For LED Strips
 up to 10mm
 Fixed Mounting Plates
 45°
 Screws Included
 600732883581



ELTSP4  1
 For LED Strips
 up to 10mm
 Endings
 Colour: Silver
 600732883598

RIN 45 Aluminium Profile for LED strips



ELTSP2  1
 For LED Strips
 up to 10mm
 Installation: Corners
 Colour: Opal
 600732883574



ELTSP8  1
 For LED Strips
 up to 10mm
 Installation: Corners
 Colour: Anodized
 6007328383727



ELTSP9  1
 For LED Strips
 up to 10mm
 Endings
 Colour: Grey
 6007328384885

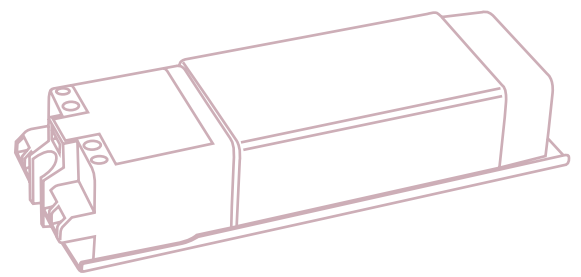

Transformers



CO76  18
50VA Electro Magnetic Transformer
Dimmable - Trailing Edge
(L)153mm x (W)43mm x (D)30mm
220V - 240V → 12V AC
6007328322566



CO79  50
10W - 60W Electronic Transformer (Blister Pack)
Dimmable - Trailing Edge
Overload and Thermal Protection
(L)100mm x (W)40mm x (D)25mm
220V - 240V → 12V AC
6007328343608

LED Drivers



CO130  1
3W LED Driver
Constant current
Short-circuit protection
100 - 240V DC 50/60Hz
350mA
ta: 50°C tc: 80°C
Power factor: >0.9
Not dimmable
IP20
(L)49mm x (W)28mm x (D)25mm
6007328346869



CO13  100
15W LED Power Supply
Constant voltage
Short-circuit protection
Thermal protection
220V - 240V → 12V DC
ta: 45°C tc: 80°C
Power factor: >0.82
Not dimmable
IP20
(L)129mm x (W)43mm x (D)20mm
6007328346456



CO14  100
30W LED Power Supply
Constant voltage
Short-circuit protection
Thermal protection
220V - 240V → 12V DC
ta: 45°C tc: 80°C
Power factor: >0.92
Not dimmable
IP20
(L)140mm x (W)45mm x (D)27.5mm
6007328346463



CO15  20
100W Waterproof LED Power Supply
Constant voltage
Short-circuit protection
Thermal protection
220V - 240V → 12V DC
Power factor: >0.9
Not dimmable
IP67
(L)230mm x (W)53mm x (D)70mm
6007328346470

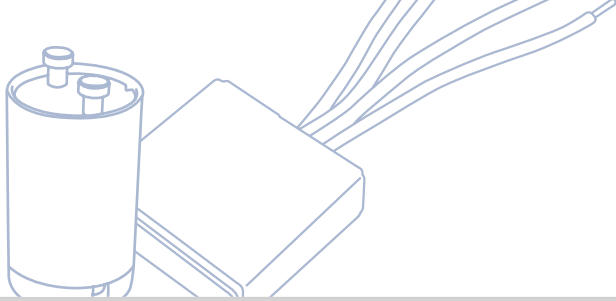

Fluorescent Starters, Backups & Dimmer Modules

Fluorescent Starters



Code	Code 2	Wattage	Material	Colour	Height	Diameter	Pack Size	Box Qty.	Barcode
CO19	ET111	4-80W	Plastic	White	38mm	20mm	1	2000	6007328369769
CO63	FSU	4-80W	Plastic	White	38mm	20mm	1	2000	6007328315063
CO64	FS2	4-22W	Plastic	White	38mm	20mm	1	2000	6007328315070
CO206	FSU	4-80W	Plastic	White	38mm	20mm	2	500	6007328357490

Dimmer Modules



CO50  1
 800W Push Button Dimmer
 Trailing Edge
 Electronic Transformers only
 (L)15mm x (W)44mm x (D)43mm
 6007328344643



CO179  1
 LED Trailing Edge
 Rotary Dimmer
 500W 2.1A Max
 Electronic Transformers only
 Dimmable LEDs only
 (L)20mm x (W)30mm x (D)66mm
 6007328361534

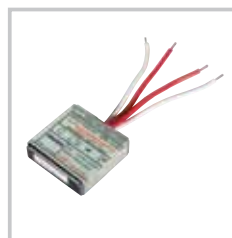

CO150  1
 LED Trailing Edge Push
 Button Dimmer
 500W 2.1A Max
 Electronic Transformers only
 Dimmable LEDs only
 (L)14mm x (W)43mm x (D)36mm
 6007328350095

Work Lights

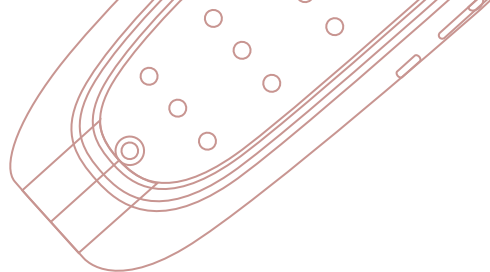

CFL Work Lights - IP44



FS105  4
 PVC with Clear Polycarbonate
 Including 1 x E27 45W 4U CFL 230V
 3m Cable & Plug Top with On / Off Switch
 (H)310mm x (W)225mm x (D)340mm
 6007328343714



FS93  2
 PVC with Clear Polycarbonate
 Including 1 x E27 20W 3U CFL 230V
 3m Cable & Plug Top with On / Off Switch
 Telescopic Stand
 (H)1760mm x (W)890mm x (D)760mm
 6007328341802



FS94  2
 PVC with Clear Polycarbonate
 Including 2 x E27 20W 3U CFL 230V
 3m Cable & Plug Top with On / Off Switch
 Telescopic Stand
 (H)1760mm x (W)890mm x (D)760mm
 6007328341819

Halogen Work Lights - IP44



FS1  12
 Steel/Aluminium with Clear Tempered Glass
 Including 1 x R7s 150W QI Premium J78 230V
 5m Cable & Plug Top with On / Off Switch
 Safety Grid
 Spare Glass: X017
 (H)290mm x (W)210mm
 6007328011972



FS2  6
 Steel/Aluminium with Clear Tempered Glass
 Including 1 x R7s 500W QI Premium J118 230V
 5m Cable & Plug Top with On / Off Switch
 Safety Grid
 Spare Glass: X020
 (H)340mm x (W)225mm
 6007328011989



FS3  1
 Steel/Aluminium with Clear Tempered Glass
 Including 1 x R7s 500W QI Premium J118 230V
 5m Cable & Plug Top with On / Off Switch
 Telescopic Stand & Safety Grid
 Spare Glass: X020
 (H)1890mm x (W)710mm
 6007328011996



FS4  1
 Steel/Aluminium with Clear Tempered Glass
 Including 2 x R7s 500W QI Premium J118 230V
 5m Cable & Plug Top with On / Off Switch
 Telescopic Stand & Safety Grid
 Spare Glass: X020
 (H)1890mm x (W)710mm
 6007328012009

Rechargeable LED Work Lights - IP65



LED



FS203 18
Steel with Clear Glass
Including 1 x Integrated 10W LED
Including car / wall charging cables
Battery Life: 3 Hours
Including insulated rocker switch
(H)200mm x (W)110mm x (D)112mm
6007328368724



FS204 8
Steel with Clear Glass
Including 1 x Integrated 20W LED
Including car / wall charging cables
Battery Life: 3 Hours
Including insulated rocker switch
(H)230mm x (W)180mm x (D)140mm
6007328368731

Rechargeable Utility Lights - IP20



FS86 6
Including 24 x 1500MCD White LED's
Including Stand & 1m Extension
Rechargeable 6V 2AH Lead Acid Battery
Charge Time: 20-24 Hours
Duration: up to 32 Hours
6007328339762



FS85 6
Including 36 x 1500MCD White LED's
Including Stand & 0.5m Extension
4x Rechargeable 4V 1AH Lead Acid Battery
Charge Time: 20-24 Hours
Duration: up to 12 Hours
6007328339793



FS87 6
Including 60 x 1500MCD White LED's
Including Stand & 1m Extension
Rechargeable 6V 2.8AH Lead Acid Battery
Charge Time: 20-24 Hours
Duration: up to 22 Hours
6007328339779



FS80 6
Including 1 x 2G7 PL5W Tube (G536BP)
Including 1 x E10 3W
Including Extension
Rechargeable 6V 2.0AH Lead Acid Battery
Charge Time: 20-24 Hours
Duration: up to 4 Hours
6007328339489



FS81 6
Including 2 x G5 6W T5 Fluorescent Tubes (G537BP)
Including 1 x E10 3W
Rechargeable 6V 4AH Lead Acid Battery
Charge Time: 20-24 Hours
Duration: up to 7.5 Hours
6007328339502



FS82 6
Including 2 x G5 8W T5 Fluorescent Tubes (G538BP)
Including Handle & Extension
Rechargeable 6V 4.0AH Lead Acid Battery
Charge Time: 20-24 Hours
Duration: up to 6 Hours
6007328339533



FS84 6
Including 2 x G5 8W T5 Fluorescent Tubes (G538BP)
Including Stand & Extension
Rechargeable 6V 4.0AH Lead Acid Battery
Charge Time: 20-24 Hours
Duration: up to 6 Hours
6007328339557



FS83 6
Including 2 x G13 20W T8 Fluorescent Tubes (G42)
Including Handle, Stand & Extension
Rechargeable 6V 4.0AH Lead Acid Battery
Charge Time: 20-24 Hours
Duration: up to 4 Hours
6007328339540

Work Lights

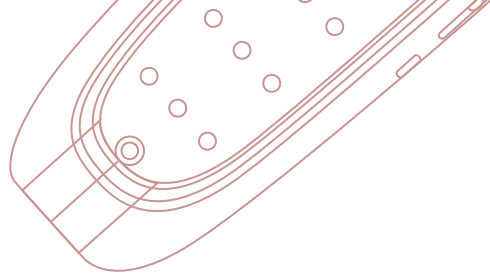

Torches & Headlamps - IP20





LED



H99  72
Including 12 x 0.06W LED 4.5V
Including 3 x AAA Batteries
Water Resistant
4 Light Functions
Adjustable Head Strap & Tilt
6007328336396





H25   48
Including 23 x LED Torch
Including 18 x LED Lantern
Including 4 x LED Emergency Light
Including 3,7V 1600mAh Li-ion
rechargeable battery
Duration Time: 4.5 Hours
Charge Time: 6 Hours
6007328347521



H150B  96
H150S
Including 3 x Bright White LED's
LED Push Light
Including Peel & Stick Backing
Excluding 3 x AAA Batteries
(Φ)70mm x (D)45mm
• **Black** 6007328359463
• **Silver** 6007328359456



H26   120
Including 1 x 0.5W LED
Including 1 x Rechargeable 4V 400mAh
lead-acid battery
Duration Time: 8 Hours
Charge Time: 20-24 Hours
6007328347538



PR209  40
Including 1 x 3W LED 4.5V
Including Charger & 95mm Recharge Cable
Rechargeable 3.7V 6.6AH Lithium-ion Battery
Battery Life: up to 16 Hours
Charge Time: 8 Hours
6007328367314



Motion Sensors



C095   100
 1200W Microwave Occupancy Sensor
 360° Detection Angle
 2-16m (24°C) Detection Distance
 Time Delay: 10sec - 7min
 Ambient Light: 3 - 2000lx
 IP20
 (H)93mm x (W)47mm x (D)43mm
 6007328346074





C096   50
 1200W Surface PIR Motion Sensor
 360° Detection Angle
 6m Detection Distance
 Time Delay: 10sec - 7min
 Ambient Light: 3 - 2000lx
 IP20
 (D)60mm x (Φ)115mm
 6007328346081



C097   50
 1200W Recessed PIR Motion Sensor
 360° Detection Angle
 6m Detection Distance
 Time Delay: 10sec - 7min
 Ambient Light: 10 - 2000lx
 IP20
 (D)60mm x (Φ)115mm
 Cut-out: 62mm
 6007328346098





C098   100
 800W PIR Motion Sensor
 180° Detection Angle
 12m (24°C) Detection Distance
 Time Delay: 10sec - 7min
 Ambient Light: 3 - 2000lx
 IP20
 (H)92mm x (W)54mm x (D)60mm
 600732834610





C0149   50
 1200W Infrared Motion Sensor
 Day/Night Mode
 Time Delay Function
 Motion Sensitivity Function
 90° Vertical Tilt & 180° Range
 Compatible with most security lights
 IP44
 (H)133mm x (W)83mm x (D)112mm
 6007328349327

Day / Night Sensors



C0203   80
 Day / Night Sensor
 Operating Voltage: 110-220V
 Ambient Light: 2 - 100lx
 IP44; Current: 25A
 (D)60mm x (Φ)115mm
 6007328357056



C0238   80
 Day / Night Sensor
 Operating Voltage: 110-220V
 Ambient Light: 2 - 100lx
 IP44, Current: 10A
 (D)53mm x (Φ)135mm
 6007328373339

Smoke Detector





C099   50
 Photoelectric Smoke Detector
 Inc. 1 x 9V DC Battery
 Low Battery Warning
 Alarm Sound: ≤85db (3m)
 Test Button
 (D)49mm x (Φ)123mm
 6007328346111

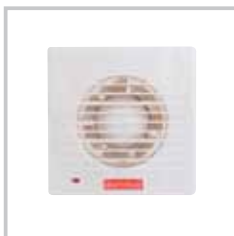

Extractor Fans

Extractor Fans without Light



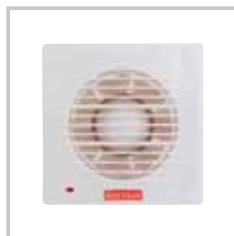

F43   12
 Plastic
 15W Motor Power @ 100m³ / hr
 (H)158mm x (W)158mm x (D)80mm
 Cut-out: 135mm
 6007328360209





F44   12
 Plastic
 25W Motor Power @ 162m³ / hr
 (H)172mm x (W)172mm x (D)85mm
 Cut-out: 149mm
 6007328360216





F45   12
 Plastic
 25W Motor Power @ 210m³ / hr
 (H)208mm x (W)208mm x (D)87mm
 Cut-out: 184mm
 6007328360223



F30   6
 Plastic
 40W Motor Power @ 360m³ / hr
 (Φ)350mm x (D)130mm
 Cut-out: 300mm
 6007328335405





F46   8
 Plastic
 30W Motor Power @ 240m³ / hr
 (Φ)300mm x (D)120mm
 Cut-out: 240mm
 6007328361121

Extractor Fans with LED Light



F31LED   4
 Plastic with Frosted PMMA Lens
 15W Motor Power @ 100m³ / hr
 Incl. 1x 12W Integrated LED
 (Φ)260mm x (D)140mm
 Cut-out: 228mm
 6007328380689



F32LED   4
 Plastic with Frosted PMMA Lens
 20W Motor Power @ 150m³ / hr
 Incl. 1x 16W Integrated LED
 (H)290mm x (W)290mm x (D)210mm
 Cut-out: 250mm
 6007328380696



F33LED   4
 Plastic with Frosted PMMA Lens
 20W Motor Power @ 150m³ / hr
 Incl. 1x 16W Integrated LED
 (Φ)290mm x (D)180mm
 Cut-out: 250mm
 6007328383345

Screwdrivers



EA168  20
 8-Piece Screwdriver Set
 Philips: PH0 x 75mm
 PH1 x 80mm
 PH2 x 100mm
 Flat: Testing Screwdriver with light
 0.5mm x 3mm x 75mm
 0.8mm x 4mm x 100mm
 1mm x 5.5mm x 125mm
 1.2mm x 6.5mm x 150mm
 6007328355694



EA234  10
 12-Piece Electrician Set
 1 x Side Cutter
 1 x Plier
 1 x Long Nose Plier
 1 x Water Pump Plier
 Philips: PH0 x 75mm
 PH1 x 80mm
 PH2 x 100mm
 Flat: Testing Screwdriver with light
 0.5mm x 3mm x 75mm
 0.8mm x 4mm x 100mm
 1mm x 5.5mm x 125mm
 1.2mm x 6.5mm x 150mm
 6007328376453

Hole Cutters



D52  6
 Downlight Hole Cutter
 Range: 30mm to 163mm
 Spare Blade: CO109
 6007328031833





D59  4
 Downlight Hole Cutter
 Range: 30mm to 260mm
 Spare Blade: CO109
 6007328322573

Hole Saw



EHS20  400
 Hole Saw HSS 20mm
 6007328388784

EHS25  400
 Hole Saw HSS 25mm
 6007328388794

EHS32  200
 Hole Saw HSS 32mm
 6007328388807

Multimeters

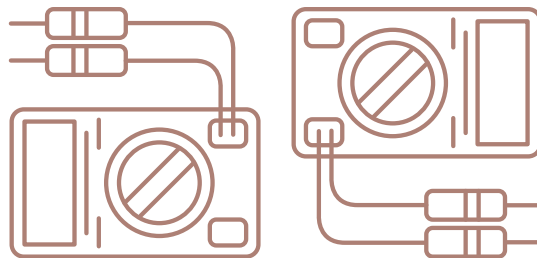

EMM6  40
Digital Multimeter

SPECIFICATIONS:

Rubber and Plastic
DC Voltage: 600mV ~ 600V
AC Voltage: 60mV ~ 600V
DC Current: 600 μ A ~ 10A
AC Current: 600 μ A ~ 10A
Resistance: 600 234 Ω 60 M Ω
Capacitance: 9.999nF 99.99mF
Temperature: 20°C - 1000°C
Battery Type: 1 x 9V
Diode Test
(H)150mm x (W)106mm x (D)36mm
6007328360582

FEATURES:

Continuity Buzzer
Data Hold
Auto Back Light
Auto Power Off
NCV
True RMS
Relative Value
Dual Display



EMM1  30
Digital Multimeter

SPECIFICATIONS:

Rubber and Plastic
DC Voltage: 200mV ~ 1000V
AC Voltage: 2V ~ 750V
DC Current: 2mA ~ 20A
AC Current: 2mA ~ 20A
Resistance: 200 Ω ~ 20M Ω
Capacitance: 9.999nF 99.99mF
Temperature: 20°C - 1000°C
Battery Type: 1 x 9V
Diode Test
(H)93mm x (W)47mm x (D)43mm
6007328360537

FEATURES:

Continuity Buzzer
Data Hold
Transistor hFE Test
Back Light
Auto Power Off
Switch Indicator Lamp
Relative Value
Bar Graph Display



EMM7  40
Digital Multimeter

SPECIFICATIONS:

Rubber and Plastic
AC Voltage: 200mV ~ 100V
DC Voltage: 200mV ~ 100V
DC Current: 200 μ A ~ 0.1 μ A
AC Current: 200 μ A ~ 0.1 μ A
Resistance: 2000 200 Ω 20 M Ω
Temperature: 20°C - 1000°C
Battery Type: 1 x 9V
Diode Test
(H)93mm x (W)47mm x (D)43mm
6007328360599

FEATURES:

Continuity Buzzer
Transistor hFE Test
Data Hold
Back Light
Auto Power Off
Relative Value
Dual Display



EMM12  30
IR Thermometer

SPECIFICATIONS:

Rubber and Plastic
Accuracy: \pm 2oc or \pm 2%
Temperature Range: 30°C - 550°C
Distance Spot Ratio: 12:1
Emissivity: 0.1 ~ 0 Adjustable
Resolution: 0.1oC or 0.1oF
Laser Target
Data Hold
Back Light
(H)93mm x (W)47mm x (D)43mm
6007328360643

FEATURES:

Max/Min/Avg
Alarm Set
Response time: 500ms
Auto Power Off
K-Type
Battery Type: 1 x 9V

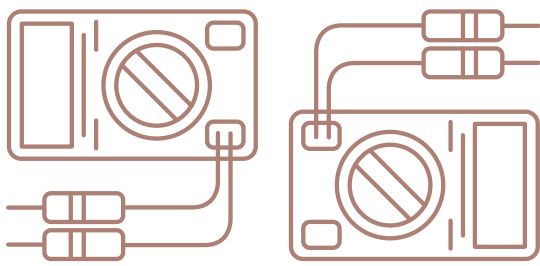

Multimeters



EMM9  50
Digital Lux Meter

SPECIFICATIONS:

Rubber and Plastic
 Measure Range: 0.1Lux ~ 100,000Lux
 Accuracy: $\leq 10,000\text{Lux}$: $\pm 4\% \text{rdg} \pm 0.5\text{fs}$
 $\geq 10,000\text{Lux}$: $\pm 5\% + 10\text{digits}$
 Resolution: 1Lux
 Repeatability: $\pm 2\%$
 Temperature Characteristic: $\pm 0.1\% / ^\circ\text{C}$
 Battery Type: 1 x 9V
 Sampling Time: 2.0 times
 Display
 (H)165mm x (W)67mm x (D)32mm
 6007328360612

FEATURES:

Black Light



EMM13  40
Laser Distance Meter

SPECIFICATIONS:

Rubber and Plastic
 Measure Range: 0.03m ~ 60m
 Accuracy: $\pm 3.0\text{mm}$
 Resolution: 1mm
 Measure Speed: 0.5sec
 Laser Type: 635 ~ 650nm, Class II, $< 1\text{mW}$
 Laser 30 seconds
 Operation Temperature: H15
 (H)122mm x (W)52mm x (D)28mm
 6007328360650

FEATURES:

Storage Temperature: F16
 Battery Life 5,000 measures
 Battery Type: 2 x 1.5V
 Back Light
 Auto Power Off



EMM4  30
Clamp Meter

SPECIFICATIONS:

Rubber and Plastic
 DC Current: 400mV 1000V
 AC Voltage: 400mV 750V
 DC Current: 200A ~ 1000A
 AC Current: 200A ~ 1000A
 Resistance: 400A ~ 1000A
 Capacitance: 40nF ~ 100μF
 Temperature: 20°C ~ 1000°C
 Frequency: 10Hz ~ 10MHz
 (H)225mm x (W)97mm x (D)40mm
 6007328360568

FEATURES:

Duty Cycle: 0.1% ~ 99.9%
 Battery Type: 1 x 9V
 Diode Test
 Continuity Buzzer
 Data Hold
 Back Light
 Relative Value
 Dual Display



EMM8  150
Multimeter

SPECIFICATIONS:

Rubber and Plastic
 Non - contact Voltage tester
 Measure Range: 90 - 1000 ACV.
 IP54
 Battery Type: 2 x 1,5V AAA batteries
 Operating voltage: DC 3V
 CATIV:1000V
 (H)155mm x (W)25mm x (D)20mm
 6007328360605

FEATURES:

Audible and visual indication
 Convenient size with pocket clip

Index

B	CO141 41	EA85 8	EA186 12	EAC61 8	EE2 19
B174 15	CO142 41	EA86 10	EA190 11	EAC62 8	EE3 19
B181 15	CO143 41	EA87 10	EA194 34	EAC63 8	EE4 19
B190 15	CO144 41	EA116 34	EA195 34	EAC64K 8	EE5 19
C	CO145 41	EA117 34	EA196 19	EAC151 8	EE6 19
C504 15	CO146 41	EA118 34	EA198 29	EAC152 8	EE7 19
CO02 35	CO147 41	EA119 34	EA199 8	EAC153 8	EE15 19
CO03 35	CO149 58	EA120K 9	EA200 33	EB11 22	EE16 19
CO04 35	CO150 54	EA121K 9	EA201 33	EB12 22	EE17 19
CO05 35	CO153W 14	EA122K 9	EA202 33	EB13 22	EE35 19
CO06 35	CO154W 14	EA123K 9	EA203 33	EB17 22	EE36 19
CO07 35	CO155W 14	EA124K 9	EA204 33	EB18 22	EFH10K 13
CO08 35	CO156W 14	EA125 30	EA205 33	EB19 22	EFH15K 13
CO09 35	CO157 14	EA126 30	EA206 33	EB20 22	EFH20K 13
CO11 35	CO158 14	EA127 30	EA207 33	EB21 22	EFH25K 13
CO13 53	CO159 14	EA128 30	EA208 33	EB22 22	EFH30K 13
CO14 53	CO160 14	EA129 30	EA209 33	EB23 21	EFH35K 13
CO15 53	CO161 14	EA130 30	EA210 33	EB24 21	EFH40K 13
CO18 42	CO162 14	EA131 30	EA211 33	EB28 24	EFH45K 13
CO19 54	CO179 54	EA132 30	EA212 33	EB29 24	EFH50K 8
CO22BR 11	CO183 12	EA133 30	EA213 33	EB30 24	EHS20 60
CO30 12	CO184 12	EA134 31	EA214 33	EB31 24	EHS25 60
CO33 12	CO185 12	EA135 31	EA215 33	EB32 24	EHS32 60
CO44BR 11	CO190 12	EA139 31	EA218 33	EB33 24	EI1-20 27
CO45 10	CO191 12	EA139S 31	EA219 33	EB34 24	EI1-35 27
CO46 10	CO192 12	EA140 31	EA220 33	EB35 23	EI1-63 27
CO47 12	CO193 12	EA141 33	EA221 29	EB36 23	EI2-20 27
CO48 12	CO203 58	EA143 34	EA222 29	EB37 23	EI2-35 27
CO50 54	CO206 54	EA159 33	EA223 29	EB38 23	EI2-63 27
CO53 10	CO238 58	EA160 33	EA224 29	EB39 23	EI3-20 27
CO54 10	D	EA161 34	EA225 7	EB40 23	EI3-35 27
CO55 10	D52 60	EA162 34	EA226 7	EB41 23	EI3-63 27
CO57 41	D59 60	EA165 33	EA227 31	EC100803 25	EI4-20 27
CO63 54	E	EA166 33	EA228K 9	EC120803 25	EI4-35 27
CO64 54	EA65 8	EA168 60	EA229K 9	EC252015 25	EI4-63 27
CO72B 10	EA66 8	EA170 2	EA230 29	EC302515 25	ELTDALMULTI 51
CO72W 10	EA67 8	EA171 34	EA231 15	EC302520 25	ELTDM1 49
CO76 53	EA68 28	EA172 34	EA233 15	EC303020 25	ELTDM2 49
CO79 53	EA69 31	EA174 10	EA233K 15	EC304020 25	ELTDM3 49
CO80 42	EA71 2	EA176 15	EA234 60	EC403020 25	ELTDM4 49
CO81 42	EA72 2	EA177B 11	EA235 31	EC404020 25	ELTDM5 49
CO95 58	EA73 2	EA177W 11	EA236 31	EC504025 25	ELTDM6 50
CO96 58	EA74 2	EA179B 11	EA237 31	EC604020 25	ELTDM7 50
CO97 58	EA75 2	EA179W 11	EA238 31	EC604025 25	ELTDM8 50
CO98 58	EA76 2	EA181 11	EA239 32	EC606025 25	ELTEB1 38
CO99 58	EA77 2	EA182 11	EA240 32	EC705025 25	ELTEB2 38
CO113 12	EA78 2	EA182F 11	EA241 32	EC806025 25	ELTEB3 37, 38
CO117 41	EA79 2	EA183 11	EA242 33	EC808030 25	ELTEB4 37, 38
CO130 53	EA84 8	EA184 12	EA243 32	ECO62 29	ELTEB5 38
CO140 41		EA185 12	EA244 33	ECO65 29	ELTEB6 38
			EA278 15	EE1 19	ELTEB7 38

ELTEB11.....39	ELTLM20.....44	EP13.....16	EWC135B.....6	EWR0510CL.....6	P PR209.....57
ELTEB12.....39	ELTLM22.....46	EP15.....16	EWC135W.....6	EWR0510W.....6	
ELTEB13.....37	ELTRC1.....50	EP16.....16	EWC1535B.....6	EWR0520BL.....6	
ELTEB14.....37	ELTSP1.....52	EP29K.....20	EWC1535W.....6	EWR0520BR.....6	
ELTEB15.....40	ELTSP2.....52	EP31.....20	EWC2535B.....6	EWR0520CL.....6	
ELTEB16.....38	ELTSP3.....52	ESW1.....10	EWC2535W.....6	EWR0520W.....6	
ELTEB17.....39	ELTSP4.....52	ESW2.....10	EWC15310B.....6	EWR0550BL.....6	
ELTEB18.....39	ELTSP5.....52	ET1.....1	EWC15310W.....6	EWR0550CL.....6	
ELTEB19.....39	ELTSP6.....52	ET2.....1	EWC15315W.....6	EWR0550W.....6	
ELTEB20.....39	ELTSP7.....52	ET3.....1	EWC15320B.....6	EWS1510W.....5	
ELTEB21.....36, 39	ELTSP8.....52	ET4.....1	EWC15320W.....6	EWS1515W.....5	
ELTEB23.....36	ELTSP9.....52	ET5.....1	EWC15325B.....6	EWS1520W.....5	
ELTEB24.....36	ELTTS1.....51	ET6.....1	EWC15325W.....6	EX61FB.....4	
ELTEB25.....36	ELTTS2.....51	ET7.....1	EWC15350B.....6	EX61FW.....4	
ELTEB26.....43	ELTTS3.....51	ET8.....1	EWC15350W.....6	EX61RB.....4	
ELTEB27.....43	EM1.....17	ET9.....1	EWC25310B.....6	EX61RW.....4	
ELTEB28.....43	EM2.....18	ET10.....1	EWC25310W.....6		
ELTEB29.....37	EM3.....18	ET11.....1	EWC25315W.....6	F	
ELTEB30.....43	EM4.....18	ET100BK.....3	EWC25320W.....6	F30.....59	
ELTEL1.....40	EM5.....17	ET100BLK.....3	EWC25325B.....6	F31LED.....59	
ELTEL2.....40	EM6.....17	ET100GK.....3	EWC25325W.....6	F32LED.....59	
ELTI1.....42	EM7.....17	ET100RK.....3	EWC25350B.....6	F33LED.....59	
ELTLD1.....47	EM8.....18	ET100WK.....3	EWC25350W.....6	F43.....59	
ELTLD2.....47	EM9.....20	ET100YK.....3	EWF155W.....5	F44.....59	
ELTLD3.....47	EM10.....20	ET101BK.....3	EWF255W.....5	F45.....59	
ELTLD5.....47, 48	EM19.....17	ETS144K.....28	EWF1510B.....5	F46.....59	
ELTLD6.....47, 48	EMM1.....61	EW1.....5	EWF1510W.....5	FS1.....55	
ELTLD14.....47	EMM4.....62	EW2.....5	EWF1515W.....5	FS2.....55	
ELTLD15.....47	EMM6.....61	EW3.....5	EWF1520W.....5	FS3.....55	
ELTLD16.....47	EMM7.....61	EW4.....5	EWF1525W.....5	FS4.....55	
ELTLD17.....47	EMM8.....62	EW5.....5	EWF1550W.....5	FS80.....56	
ELTLD18.....39	EMM9.....62	EW6.....5	EWF2510W.....5	FS81.....56	
ELTLD19.....48	EMM12.....61	EW7.....5	EWF2515W.....5	FS82.....56	
ELTLD20.....48	EMM13.....62	EW8.....5	EWF2520W.....5	FS83.....56	
ELTLD21.....48	EN253015.....26	EW9.....5	EWF2525W.....5	FS84.....56	
ELTLD22.....47, 48	EN403020.....26	EW10.....5	EWF2550W.....5	FS85.....56	
ELTLD23.....48	EN406020.....26	EW11.....5	EWGP155B.....5	FS86.....56	
ELTLD24.....48	EN606025.....26	EW12.....5	EWGP155GY.....5	FS87.....56	
ELTLM1.....45	EN608020.....26	EW13.....5	EWGP155R.....5	FS93.....55	
ELTLM2.....45	EN801003.....26	EW14.....5	EWGP2510B.....5	FS94.....55	
ELTLM4.....45	EP1.....16	EW15.....5	EWGP2510GY...5	FS105.....55	
ELTLM5.....45	EP2.....16	EW16.....5	EWGP2510R.....5	FS203.....56	
ELTLM7.....45	EP3.....16	EW17.....6	EWGP2520B.....5	FS204.....56	
ELTLM8.....45	EP6K.....20	EW18.....6	EWGP2520GY...5		
ELTLM10.....46	EP6SK.....20	EW19.....6	EWGP2520R.....5	H	
ELTLM11.....46	EP7.....20	EW20.....6	EWR055BL.....6	H25.....57	
ELTLM13.....44	EP8K.....20	EW21.....6	EWR055BR.....6	H26.....57	
ELTLM14.....44	EP8SK.....20	EW22.....6	EWR055CL.....6	H99.....57	
ELTLM16.....44	EP9.....16	EW23.....6	EWR055W.....6	H150.....57	
ELTLM17.....44	EP10.....16	EW24.....6	EWR0510BL.....6		
ELTLM19.....44	EP12.....16	EW25.....6	EWR0510BR.....6		

Customised Merchandising Solutions To Meet Your Needs



**Eurolux Electrical
Accessory
merchandising
stands are available
for orders of
electrical product.**



CAPE TOWN - Head Office

9 Racecourse Road
Milnerton
7441

Tel: +27 (0)21 528 8400
Fax: +27 (0)21 528 8500
Email: info@eurolux.co.za

JOHANNESBURG

10 Milkyway Avenue
Linbro Business Park
Sandton 2065

Tel: +27 (0)11 608 2970
Fax: +27 (0)11 608 2975
Email: jhb@eurolux.co.za

www.eurolux.co.za